

## Operating Manual Pt100 Precision Thermometer

# GMH 2710 - ...

as of version V1.0



GMH 2710-T

GMH 2710-E

GMH 2710-K

GMH 2710-G



WEEE-Reg.-Nr. DE 93889386

## Index

<b>1</b>	<b>DESIGNATED USE</b> .....	<b>2</b>
<b>2</b>	<b>GENERAL NOTE</b> .....	<b>2</b>
<b>3</b>	<b>SAFETY REQUIREMENTS</b> .....	<b>3</b>
<b>4</b>	<b>DISPLAY AND CONTROL ELEMENTS</b> .....	<b>3</b>
4.1	DISPLAY ELEMENTS .....	3
4.2	CONTROL ELEMENTS .....	3
4.3	POP-UP CLIP .....	4
<b>5</b>	<b>START OF OPERATION</b> .....	<b>4</b>
<b>6</b>	<b>BASICS</b> .....	<b>5</b>
<b>7</b>	<b>CONFIGURATION OF THE DEVICE</b> .....	<b>5</b>
<b>8</b>	<b>ADJUSTMENT</b> .....	<b>6</b>
<b>9</b>	<b>REPLACING BATTERIES</b> .....	<b>6</b>
<b>10</b>	<b>ERROR AND SYSTEM MESSAGES</b> .....	<b>7</b>
<b>11</b>	<b>ACCURACY INSPECTION: ADJUSTMENT /UPDATE SERVICE</b> .....	<b>7</b>
<b>12</b>	<b>DISPOSAL NOTES</b> .....	<b>7</b>
<b>13</b>	<b>TECHNICAL DATA</b> .....	<b>7</b>

## 1 Designated Use

The device is measuring temperature in °C or °F.

The safety requirements (see below) have to be observed.

The device must be used only according to its intended purpose and under suitable conditions.

Use the device carefully and according to its technical data (do not throw it, strike it, ...).

## 2 General Note

Read this document carefully and get used to the operation of the device before you use it. Keep this document within reach for consulting in case of doubt.

If the device is stored at temperatures above 50°C the battery has to be removed from the device.

**NOTE:** We recommend taking out battery if device is not used for a longer period of time.



Risk of leakage!

## 3 Safety Requirements

This device has been designed and tested in accordance with the safety regulations for electronic devices. However, its trouble-free operation and reliability cannot be guaranteed unless the standard safety measures and special safety advises given in this manual will be adhered to when using the device.

1. Trouble-free operation and reliability of the device can only be guaranteed if the device is not subjected to any other climatic conditions than those stated under "Specification".

If the device is transported from a cold to a warm environment condensation may cause in a failure of the function. In such a case make sure the device temperature has adjusted to the ambient temperature before trying a new start-up.

2. **WARNING:** If there is a risk whatsoever involved in running it, the device has to be switched off immediately and to be marked accordingly to avoid re-starting.



Operator safety may be a risk if:

- there is visible damage to the device
- the device is not working as specified
- the device has been stored under unsuitable conditions for a longer time.

In case of doubt, please return device to manufacturer for repair or maintenance.

3. **WARNING:** Do not use these products as safety or emergency stop devices or in any other application where failure of the product could result in personal injury or material damage.



Failure to comply with these instructions could result in death or serious injury and material damage.

## 4 Display and Control Elements

### 4.1 Display elements



1: **Main display**

Display of the current temperature

2: **Secondary display**

On demand: Display of MIN , Max or hold-value, with MIN/MAX/HLD-symbols

### 4.2 Control elements



**Key 1:** **on/off key**

**Key 2:** **max/min**

press shortly: minimum value

press again: maximum value

press again: return to standard display

press for 2 sec.: reset minimum and maximum values

**Key 3:** **hold: (auto hold deactivated)**

press shortly: The measuring current value is 'frozen' (hold-function), 'HLD' is displayed

**hold: (auto hold activated)**

press shortly: Restart "catching" of stable value

## 4.3 Pop-up clip

### Handling:

- Pull at label "open" in order to swing open the pop-up clip.
- Pull at label "open" again to swing open the pop-up clip further.

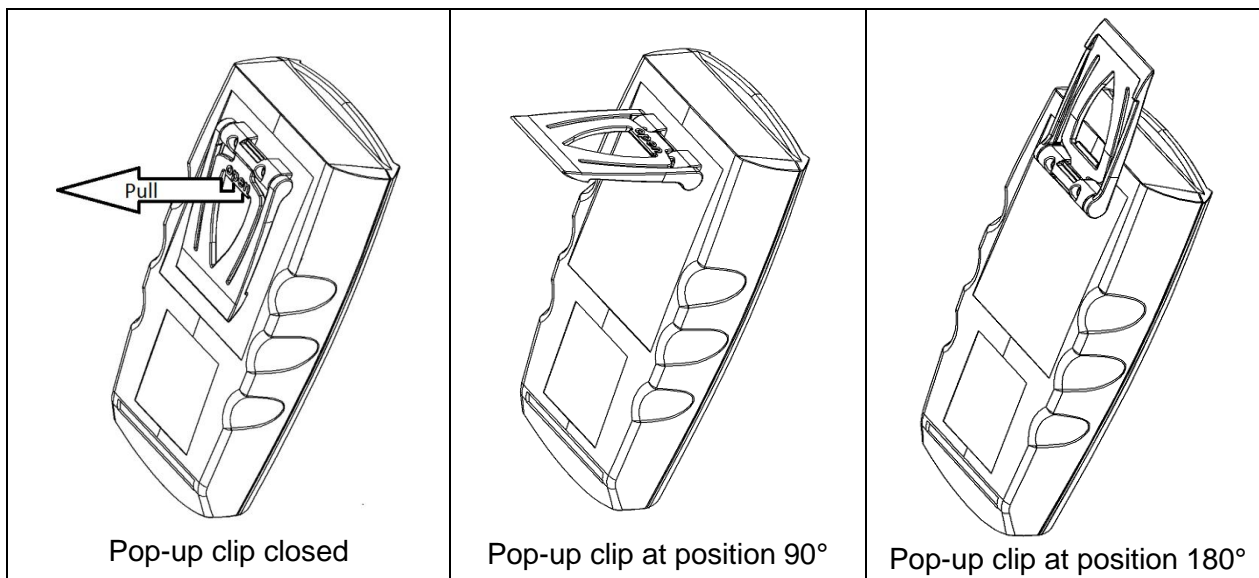

### Function:

- The device with a closed pop-up clip can be plainly laid onto a table or attached to a belt, etc.
- The device with pop-up clip at position 90° can be set up on a table, etc.
- The device with pop-up clip at position 180° can be suspended from a screw or the magnetic holder GMH 1300.

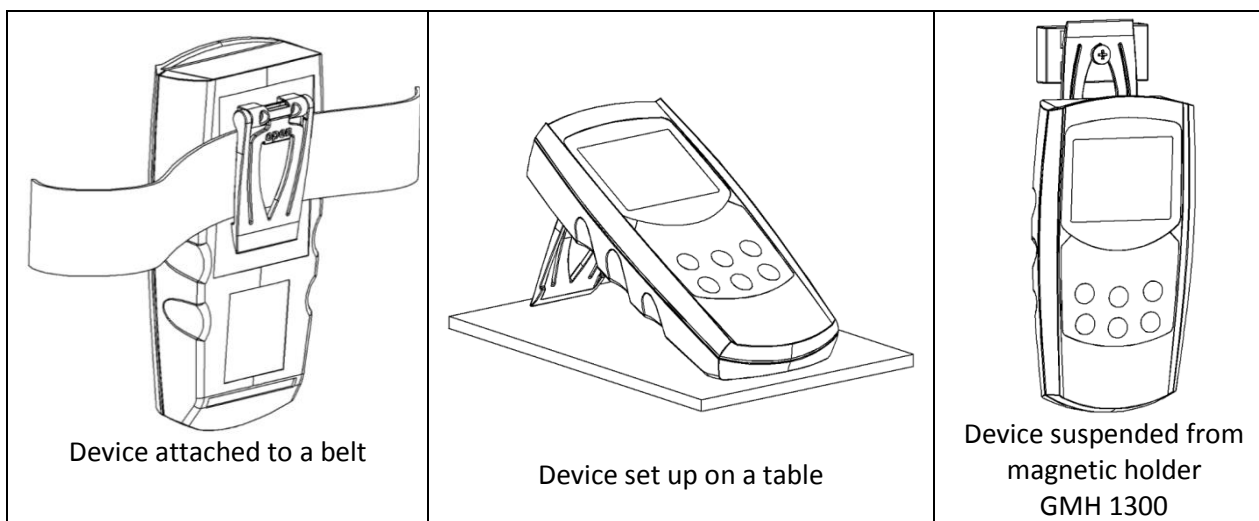

## 5 Start of Operation

Switch the device on with the key  .

After segment test



the device displays some information to

its configuration:

*OFFS* if there is a offset adjustment (p.r.t. chapter 8)

*SCAL* if there is a slope adjustment (p.r.t. chapter 8)

*P.oFF* if the automatic-off-function is activated (p.r.t chapter 7)

The device is ready for measuring afterwards.

## 6 Basics

### Probe Precision/Device Precision

The device has a very good system accuracy (please refer to technical data). This is due to the calibration of the probe acc. To the connected instrument plus the use of precise measurement electronics and premium Pt1000 sensor elements

### Heat loss caused by probe construction:

Especially when measuring temperatures which deviate very much from the ambient temperature, measuring errors often occur if the heat loss caused by the probe is not considered. When measuring fluids therefore the probe should be emerged sufficiently deep (at least 5 times of diameter, i.e. >15mm) and be stirred continuously. When measuring gases the probe should also emerge as deep as possible in the gas to be measured (e.g. when measuring in channel/pipes) and the gas should flow around the probe at sufficient flow.

### Allowable Temperature Range Of Probes

For the two variants there are different application areas:

*GMH 2710: (black plastic handle)*





The allowable temperature range of -200 to 200 °C only is valid for the probe tube, the (plastic) handle must not be heated above 80°C, the cable utmost 105°C! Therefore only front part of the stainless steel tube is allowed to be heated above 80°C!



*GMH 2710-K (white Teflon handle)*

Both cable and handle are capable of -200 bis +250°C!

## 7 Configuration of the Device

Follow these instructions to configure the functions of the device:

- Switch the device on.
- Press  and  together until the first parameter "Unit" is displayed.
- Set parameter with  = up or  = down.
- Jump to the next parameter by pressing .

Parameter	Value	Information
<b>button</b> 	<b>buttons</b>  	
<b>Unit</b>	<b>Display unit</b> <i>factory setting: °C</i>	
	°C	Measuring value displayed in °Celsius
	°F	Measuring value displayed in °Fahrenheit
<b>Auto</b> HLD	<b>Auto Hold-Function</b> <i>factory setting: OFF</i>	
	on	<b>Auto Hold activated:</b> automatic holding of the measured value, as soon as it is stabilized.
	off	<b>Auto Hold deactivated:</b> Value is frozen on keypress (hold)
<b>P.off</b>	<b>Auto Power-Off</b> (turn-off delay) <i>factory setting: 20 min.</i>	
	1 ... 120	<b>Auto Power-Off</b> (turn-off delay) in minutes. If no key is pressed for the time adjusted here, the device is automatically switched off (adjustable 1 ... 120 min)
	off	Auto power-off is deactivated (continuous operation)
<b>init</b>	<b>Restore factory settings</b>	
	no	Parameters are not changed to factory settings.
	YES	<b>ATTENTION:</b> All parameter are changed to factory settings.

Press  again to store changed settings, the device restarts (segment test).

**NOTE:** If there is no key pressed within the menu mode within 2 minutes, the configuration will be cancelled, the entered settings are lost!





## 8 Adjustment



The instrument can be adjusted, assuming that: Reliable references are available, such as ice-water regulated precision water baths or similar.

$$\text{Displayed value } ^\circ\text{C} = (\text{measured value } ^\circ\text{C} - \text{OFFS}) * (1 + \text{slope correction} / 100)$$

$$\text{Displayed value } ^\circ\text{F} = (\text{measured value } ^\circ\text{F} - 32 - \text{OFFS}) * (1 + \text{slope correction} / 100)$$

Follow these instructions to adjust the device:

- Switch the device on.
- Press  and  together until the first parameter "OFFS" is displayed.
- Set parameter with  = up or  = down
- Jump to the next parameter by pressing .

Parameter	Value	Information
	 	
<b>OFFS</b>	<b>OFFSET correction</b> <i>factory setting: oFF = 0.0°C</i>	
	<b>oFF</b>	No offset correction
	<b>-25 ... 25 °C</b> or <b>-45...45 °F</b>	Value of offset correction
<b>SCAL</b>	<b>Slope correction</b> <i>factory setting: oFF= 0%</i>	
	<b>oFF</b>	No slope correction
	<b>-5.00 ... 5.00</b>	Value of slope correction in %

Press  again to store changed settings, the device restarts (segment test).

**NOTE:** If there is no key pressed within the menu mode within 2 minutes, the configuration will be cancelled, the entered settings are lost!

## 9 Replacing Batteries

Before changing batteries, please read the following instruction and follow it step by step.



Not following the instruction may cause harm to the instrument or the protection against ingress of water and dust may be lost!

Avoid unnecessary opening of the instrument!

1. Open the 3 Phillips screws at the backside of the instrument.
2. Lay down the still closed instrument, so that the display side points upwards.  
The lower half of the housing incl. The electronics should be kept lying down during battery change.  
This avoids loss of the sealing rings of the screw holes.
3. Lift upper half of housing. Keep an eye on the three function keys, to be sure not to damage them.
4. Change carefully the two batteries (Type: AAA).
5. Check: Are the 3 sealing rings placed in the housing?  
Is the circumference seal of the upper half sound and clean?
6. Close the housing, taking care that it is positioned correctly, otherwise the sealing may be damaged.  
Afterwards press the two halves together, lay the instrument with display pointing downwards and screw it together again

**Take care to screw only until you feel increasing resistance, higher screwing force does not result in higher water protection!**

## 10 Error and System Messages

Err. 1	Value exceeding measuring range, value too high or cable/sensor broken
Err. 2	Value exceeding measuring range, value too low or cable/sensor shorted
Err. 7	System error – the device has detected a system error (device defective or not within working temperature)
	The blinking bAt display indicates low battery voltage, device will continue to work for a short time.
	The battery is consumed and has to be changed. Measurements are no longer possible.

## 11 Accuracy Inspection: Adjustment /Update Service

You can send the device to the manufacture or retailer for adjustment and inspection. Moreover the manufacturer can do the latest software update. This ensures that future improvements are provided to owners of older devices in a cost-saving way. You can display the current software version if you do not release the on/off button after you switched the device on, but hold it for more than 5 seconds. (i.e. "r. 1.0")

## 12 Disposal Notes



Dispense exhausted batteries at destined gathering places.  
This device must not be disposed as 'residual waste'  
To dispose this device, please send it directly to us (adequately stamped).  
We will dispose it appropriately and environmentally friendly.

## 13 Technical Data

<b>Measurement</b>	Resistive temperature measuring Pt1000
<b>Range</b>	GMH 2710-T, ...-E: -199,9°C to 200,0°C / -199,9°F to 392,0°F GMH 2710-K, ...-G: -199,9°C to 250,0°C / -199,9°F to 482,0°F
<b>Resolution</b>	0.1°C / 0.1°F
<b>Accuracy</b>	-20.0 ... 100.0°C: +/-0.1°C +/-1 digits -70.0 ... 200.0(250.0) °C: +/-0,1 % of measured value +/-2 digits
<b>T90</b>	< 10s in water
<b>Display</b>	Two 4 ½ digits LCD's (12.4 mm high and 7 mm high) for temperature, min./ max values, hold function, etc. as well as additional pointing arrows.
<b>Hold function</b>	Press button to freeze current value. Auto hold: a stable value will automatically be captured with "HLD"
<b>Probe: GMH 2710-T</b>	Plastic handle 135 mm long (max. 80°C), 1 m PVC cable (-20...105°C), stainless steel tube d = 3 mm, l = 100 mm
<b>GMH 2710-E</b>	Plastic handle 135 mm long (max. 80°C), 1 m PVC cable (-20...105°C), stainless steel tube d = 3 mm, l = 100 mm, insertion tip
<b>GMH 2710-K</b>	Teflon handle incl. stainless steel bending protection (max. 250°C), 1 m teflon cable (max. 250°C), stainless steel tube d = 3 mm, l = 100 mm, insertion tip
<b>GMH 2710-G</b>	Small Teflon handle incl. stainless steel bending protection (max. 250°C), 1 m teflon cable (max. 250°C), stainless steel tube d = 1.5 mm, l = 100 mm, insertion tip
<b>Working temperature</b>	-25 to 50°C
<b>Storage temperature</b>	-25 to 70°C
<b>Power supply</b>	2x AAA Alkaline cells (included)
Power consumption	< 0.25 mA (battery life time: more than 4000 hours for alkaline battery)
battery state display	"bAt" displayed if battery used, warning: "bAt" in secondary display
<b>Auto off-function</b>	Device will be automatically switched off if not operated for longer time (adjustable from 1..120 min)
<b>Housing</b>	impact-resistant ABS plastic housing
Protection rate	IP65 (splash water resistant) and IP67 (waterproof: short time 1 meter)
Dimension	Approx. 154 x 81 x 31 mm (H x W x D)
Weight	Approx. 190 g incl. battery

<b>EMC</b>	The device corresponds to the essential protection ratings established in the Regulations of the Council for the Approximation of Legislation for the member countries regarding electromagnetic compatibility (2004/108/EG), additional error: < 1% FS
------------	---------------------------------------------------------------------------------------------------------------------------------------------------------------------------------------------------------------------------------------------------------



## EC - Declaration of Conformity

For the following identified products

### GMH 2710

will certified herewith, that the device corresponds to the essential protection ratings established in the Regulations of the Council for the Approximation of Legislation for the member countries regarding electromagnetic compatibility (2004/108/EG) and the low voltage directives (2006/95/EG).

The conformity to EMC are verified under observance of following standards:

**EN 61326-1 : 2006** (addendum A, class B)

This declaration is responsible for the manufacturer

GREISINGER electronic GmbH  
Hans-Sachs-Straße 26  
D - 93128 Regenstauf

released by

Hinreiner, Alois  
Director BU

Regenstauf  
place

17.01.2012  
date

  
signature