

Temperature probes for potentially explosive atmospheres

Operating Manual

GTF 101-Ex ... GTF 102-Ex ...



GHM GROUP - Greisinger

GHM Messtechnik GmbH | Hans-Sachs-Str. 26 | 93128 Regenstauf | GERMANY
Tel.: +49 9402 9383-0 | info@greisinger.de | www.greisinger.de

INDEX

1	GENERAL NOTE	3
2	SAFETY	3
2.1	Intended Use.....	3
2.2	Safety signs and symbols	3
2.3	Skilled personnel.....	4
2.4	Safety guidelines.....	4
2.4.1	General information.....	4
2.4.2	Additional safety instructions for zone 0 or zone 20.....	5
2.4.3	Additional safety instructions for zone isolation	5
3	PRODUCT DESCRIPTION.....	5
3.1	General information.....	5
3.2	Scope of delivery.....	5
3.3	Identification.....	6
3.4	Which temperature probe, transmitter do I need?	6
3.5	Probe types.....	7
3.6	Connection values.....	8
3.6.1	Approval 'e' increased safety.....	8
3.6.2	Approval 'i': intrinsically safe.....	8
4	NOTES ON OPERATION IN POTENTIALLY EXPLOSIVE ATMOSPHERES.....	9
4.1	Self-heating of the probe.....	9
4.2	Permissible ambient temperatures and neck pipe.....	11
4.2.1	For Types GTF 101-Ex-i-... and GTF 102-Ex-i.....	11
4.2.2	For Types GTF 101-Ex-e-... and GTF 102-Ex-e.....	11
5	INSTALLATIONS INSTRUCTION.....	12
5.1	Connection assignment for Pt100 and Pt1000.....	12
5.2	Connection assignment for thermocouple type K.....	12
5.3	Cable and conductor gland (CCG).....	12
6	SPECIFICATION	12
6.1	Dimensions	14
7	DECOMMISSIONING, RESHIPMENT AND DISPOSAL.....	14
7.1	Reshipment.....	14
7.2	Disposal instructions	14
8	ORDERING INFORMATION	15
8.1	Ordering code for GTF 101-Ex-... probes.....	15
8.2	Ordering code for GTF 102-Ex-... probes.....	16
9	EU - DECLARATION OF CONFORMITY	17
10	EU - TYPE EXAMINATION CERTIFICATE	18

1 General note

Please read this document carefully and familiarize yourself with the operation of the device before using it. Keep this document within easy reach near the device for consulting in case of doubt.

2 Safety

2.1 Intended Use

These resistance thermometers and thermocouples are designed for temperature measurement in explosion-prone areas in industrial applications.

The measuring range, depending on the version, covers temperatures from **-200 °C +600 °C (900 °C with thermocouple)**, in which this can be limited due to the temperature class of the Ex area.

The probes are intended exclusively for use within the technical limit values indicated on the type plate and in this operating manual.

Only technically qualified personnel are permitted to carry out installation, commissioning, operation and decommissioning. The qualified personnel must have carefully read and understood the operating manual before starting work.

The compatibility of the measuring medium and the housing material getting in touch with the medium, must be assured so that no impairments of operational safety can arise

The liability and warranty of the manufacturer for damages and consequential damages are voided with misuse, disregard of this operating manual, assignment of inadequately qualified technical personnel and arbitrary modifications of the product.

2.2 Safety signs and symbols

Warnings are labelled in this document with the followings signs:



Caution!

This symbol warns of imminent danger, death, serious injuries and significant damage to property at non-observance



Caution!

This symbol indicates a potentially dangerous situation in explosion-prone areas that can result in death or severe injuries if not avoided.



Attention!

This symbol warns of possible dangers or dangerous situations which can provoke damage to the device or environment at non-observance.



Note!

This symbol points out processes which can indirectly influence operation or provoke unforeseen reactions at non-observance.

2.3 Skilled personnel









are persons who are familiar with the set-up, installation, commissioning and operation of the product and have appropriate qualification for their work. For example:

- Training or instruction and/or authorization to activate, deactivate, disconnect, ground and identify power circuits and devices/systems in accordance with the standards of safety engineering.
- Training or instruction in accordance with the standard of safety technology for care and use of suitable safety equipment.
- Knowledge about the installation of devices in explosion-prone areas.

2.4 Safety guidelines



This device has been designed and tested in accordance with the safety regulations for electronic devices. However, its trouble-free operation and reliability cannot be guaranteed unless the standard safety measures and special safety advises given in this manual will be adhered to when using the device.

2.4.1 General information

1.  Requirements of Directive 2014/34/EU (ATEX) and IECex must be observed. The respective national regulations for Ex use must also be complied with (e.g. EN 60079-10 and EN 60079-14).
2.  Install the GTF 101-Ex and GTF 102-Ex according to the manufacturer's specifications and the valid standards and regulations.
3.  The temperature probe must only be connected to the feed devices provided for this purpose and approved for operation of the system for passive resistance sensors and thermocouples according to the appropriate standard. The electrical operating values must not be exceeded.
4.  **In ignition protection rating 'e' (increased safety)**, a fuse corresponding to the specifications of EC type examination certificate and suitable for a possible short-circuit current of 1500 A must be installed upstream from every temperature probe in a suitable manner ..
5.  **In ignition protection rating 'i' (intrinsically safe)** the probe must be earthed!
6. The ambient temperatures for the cable sleeve must be observed.
7. The connections must be made according to the connection diagram.
8.  Depending on the measuring current, the self-heating at the sensor tube must be considered for the application.
The sum of the process temperature and the temperature from self-heating of the probe tube must always be less than the ignition temperature of the medium. The required safety distances must be observed.
9.  ATTENTION The compatibility of the device materials used with your probe version and the measuring medium must be assured.
10.  ATTENTION Use of the probe tube or housing as a climbing aid (e.g. for installation purposes) or as a holder for additional external loads is not permitted!
11.  ATTENTION Mechanical modifications of the product (e.g. application of material by means of painting, removal of material by means of drilling into the housing) are not permitted!



2.4.2 Additional safety instructions for zone 0 or zone 20

These instructions must also be observed if the probe and connection sleeve are installed in this zone.

1.  Explosion-prone mixtures must only form under the following atmospheric conditions: $-20^{\circ}\text{C} \leq T_a \leq +60^{\circ}\text{C}$ and $0.8 \text{ bar} \leq p \leq 1.1 \text{ bar}$.
2. The limited environmental temperatures must be complied with (see chapter 4.1)
3.  The feeding supply circuit must satisfy ignition protection rating Ex ia IIC and/or Ex ia IIIC.

2.4.3 Additional safety instructions for zone isolation

These instructions must also be observed if the probe is installed in Zone 0 and/or 20 and the head in zone 1, 2, 21 or 22.

1.  Only use versions that are suitable for zone separation!
2.  A gas-tight must be assured after installation!

3 Product description

3.1 General information

The GTF 101-Ex and GTF 102-Ex temperature probes are designed as integrated probes for use in explosion-prone areas. The probes are very small, so they can be used in places that are difficult to access. Also, the probes are assembled complete with connection cable, so the connection must be made directly to the terminal only.

The measuring insets of the GTF 111-Ex and GTF 112-Ex are firmly sealed and cannot be exchanged. They are available in 2 different groups of sensor elements,

resistance thermometer: Pt 100, Pt 1000 or **thermocouple:** type K.

Only mineral-insulated resistance thermometers and/or mineral-insulated thermocouples are used as sensor elements.

The range of use, depending on the version, theoretically covers a medium temperature of **-200 °C to +600 °C (900 °C)**, which is limited by the temperature class of the Ex area!

At process temperatures above 100 °C the probe must have a correspondingly large neck pipe length. The neck tube length must be selected such that the permissible environmental temperature of the head is not exceeded or fallen below, depending on the measuring temperature and the installation situation.

GTF 101-Ex must have a sufficient distance from the compression fitting to the sleeve at temperature being kept above 100 °C or below -50 °C. For this purpose, an additional tubular sleeve is provided as a stop for the neck length.

There a multitude of **base types of GTF 101-Ex and GTF 102-Ex** available that can all be custom assembled.

We recommend the series GTF 103-Ex for applications with head transmitters or terminal block.

3.2 Scope of delivery

Temperature sensor, operating instructions

3.3 Identification

Examples for type plates

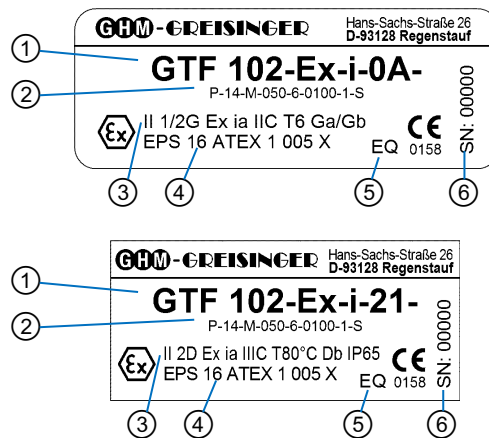
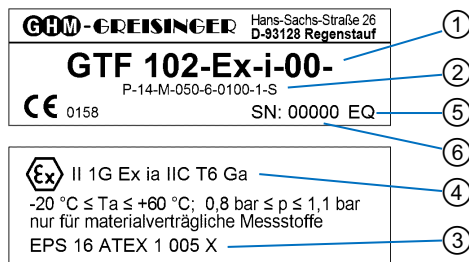

- ① Base type
- ② Extension of the variant code
(Type designation = ① + ②)
- ③ Approval number
- ④ Ex identification
- ⑤ Code for month/year of manufacture: MY
 M: A = January, B = February, ..., L = December
 Y: P = 2015, Q = 2016, R = 2017, ..., Z = 2025
 (Example: EQ = May 2016)
- ⑥ Serial number

3.4 Which temperature probe, transmitter do I need?

You can easily determine the temperature probe or temperature transmitter for your specific application from the table below.

Zone 0 or 20

If the temperature must be detected in Ex Zone 0 or 20, the appropriate GTF101-Ex or GTF102-Ex temperature probe in ignition protection class II 1G Ex ia IIC... or II 1D Ex ia IIIC... can be used.

Only ATEX-approved devices can be used as display and/or control devices that meet the requirements of the corresponding zones.

Zone 0/1 or 20/21 (zone-separating)

If the temperature must be detected in Ex Zone 0 or 20 and the probe connection is outside of this zone, the probe must be installed as appropriately zone-separating. For this purpose, the appropriate, suitable GTF101-Ex or GTF102-Ex temperature probes in ignition protection class II 1/2G Ex ia IIC... or II 1/2D Ex ia IIIC... are used.

Only ATEX-approved devices can be used as display and/or control devices that meet the requirements of the corresponding zones.

Zone 1, 2 or 21, 22

If the temperature must be detected in Ex Zone 1, 2 or 21, 22, the appropriate GTF101-Ex or GTF102-Ex temperature probe in ignition protection class II 2G Ex ia IIC..., II 2G Ex em IIC... or II 2D Ex ia IIIC..., II 2D Ex mb IIIC... can be used.

If the display and/or control device is in Zone 1, 2 or 21, 22, only ATEX-approved devices of the appropriate zone can be used.

If the display and/or regulating device is outside of the Ex area, Ex approval is not required if the GTF 101/102-Ex temperature probe in ignition protection class Ex em IIC... or Ex mb IIIC... is used and the safety instructions from chapter **Fehler! Verweisquelle konnte nicht gefunden werden.** as well as the electrical supply data are observed.

Table 1: Overview of use and requirements for the GTF 101-Ex-... and GTF 102-Ex-... in the individual Ex zones.

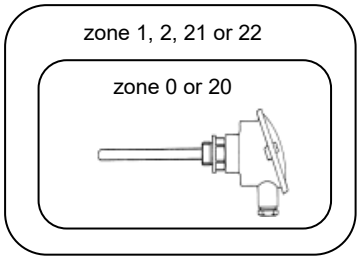
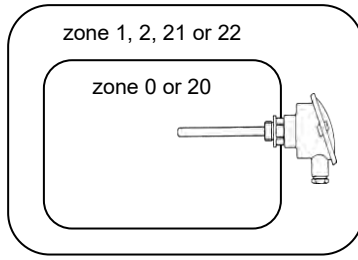
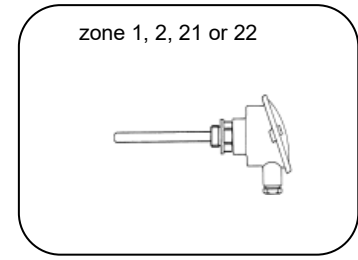
Ex zone	0	20	Zone isolation		1, 2	21, 22
			0/1	20/21		
Usable types	GTF 101-Ex-i-00-.. GTF 102-Ex-i-00-..	GTF 101-Ex-i-20-.. GTF 102-Ex-i-20-..	GTF 102-Ex-i-0A-..	GTF 102-Ex-i-2A-..	GTF 101-Ex-i-01-.. GTF 102-Ex-i-01-.. GTF 101-Ex-e-01-.. GTF 102-Ex-e-01-..	GTF 101-Ex-i-21-.. GTF 102-Ex-i-21-.. GTF 101-Ex-e-21-.. GTF 102-Ex-e-21-..
ATEX identification of probes	II 1G Ex ia IIC T6 Ga Ta = -20 ... +60 °C	II 1D Ex ia IIIC T80°C Da IP65 Ta = -20 ... +60 °C	II 1/2G Ex ia IIC T6 Ga/Gb	II 1/2D Ex ia IIIC T80°C Da/Db IP65	II 2G Ex ia IIC T6 Gb <i>or</i> II 2G Ex e m IIC T6 Gb	II 2D Ex ia IIIC T80°C Db IP65 <i>or</i> II 2D Ex mb IIIC T80°C Db IP65
						

3.5 Probe types

The GTF 101-Ex and GTF 102-Ex are available in a variety of different versions, depending on the selected sensor element, the medium temperature, the ambient temperature range or the necessary protection.

Standard probes have a probe length of 100 mm, a probe tube diameter of 6 mm, (neck tube the GTF 101-Ex = 8mm) and the GTF 102-Ex has a thread G = 1/2".

We assemble the sensor according to your specifications, as far as the specifications for the GTF 101-Ex -... or GTF 102-Ex- ... are possible (see technical data).

GTF 101-Ex-...-K-...



GTF 101-Ex-...-M-...



GTF 102-Ex-...-XX-K-...



GTF 102-Ex-...-XX-M-...



3.6 Connection values

3.6.1 Approval 'e' increased safety

Measuring current circuit:

Rated voltage	=	4 V
Rated measuring current	=	10 mA

Maximum permissible short-circuit current for current circuit:

for version with sensor Pt100 or Pt1000:	500mA
for version with sensor thermocouple type K:	100 mA



Observe the notes in chapter 4

3.6.2 Approval 'i': intrinsically safe

Measuring circuit only for connection to certified intrinsically safe power circuits with the following maximum values:

U_i	=	30 V
I_i	=	300 mA
P_i	=	see table ¹⁾
C_i	=	negligibly small*
L_i	=	negligibly small*

Cabel	Sensor	C_i	L_i
Silicone cable	Pt100/Pt1000	100 pF / m	1 μ H / m
PVC cable	Pt100/Pt1000	100 pF / m	1 μ H / m
Teflon cable	Pt100/Pt1000	100 pF / m	1 μ H / m
Silicone compensating cable	Typ K	200 pF / m	2 μ H / m

¹⁾The maximum permissible output of the connected intrinsically safe power circuit P_i depends on the temperature class of the temperature sensor, the sensor diameter, the zone in which the sensor is used and the process temperature. Please observe the notes in chapter 4

Maximum permissible power P_i and permissible ambient temperature T_a , depending on temperature class, zone and sensor diameter D				
temperature class	Zone	P_i [mW]		T_a
		$D = 3, 4, 5$ mm	$D \geq 6$ mm	
T6	0	15 mW	15 mW	-20...60 °C
T5	0	80 mW	200 mW	-20...60 °C
T4	0	250 mW	600 mW	-20...60 °C
T3	0	650 mW	1200 mW	-20...60 °C
T2	0	1400 mW	1500 mW	-20...60 °C
T1	0	1500 mW	1500 mW	-20...60 °C
T6	1, 2	80 mW	250 mW	-20...60 °C
T5	1, 2	80 mW	200 mW	-20...80 °C
T4	1, 2	300 mW	750 mW	-20...80 °C
T3	1, 2	750 mW	1500 mW	-20...80 °C
T2	1, 2	1500 mW	1500 mW	-20...80 °C
T1	1, 2	1500 mW	1500 mW	-20...80 °C

4 Notes on operation in potentially explosive atmospheres

4.1 Self-heating of the probe

A maximum of 20 mW should be applied to the measuring current circuit. When this value is observed, the temperature on the probe tube increases by a maximum of 4 °C in relation to the environmental temperature. The GTF 101-Ex and GTF 102-Ex must only be used if this temperature increase in relation to the process temperature is permissible.

If, in the event of a fault, the measuring circuit is loaded more, the self-heating of the sensor tube must be taken into account.

The sum of process temperature and temperature caused by self-heating at the sensor tube must always be lower than the ignition temperature of the medium - even in the event of a fault!

The required safety distances must be taken into account

Over temperature with loading of the measuring current circuit

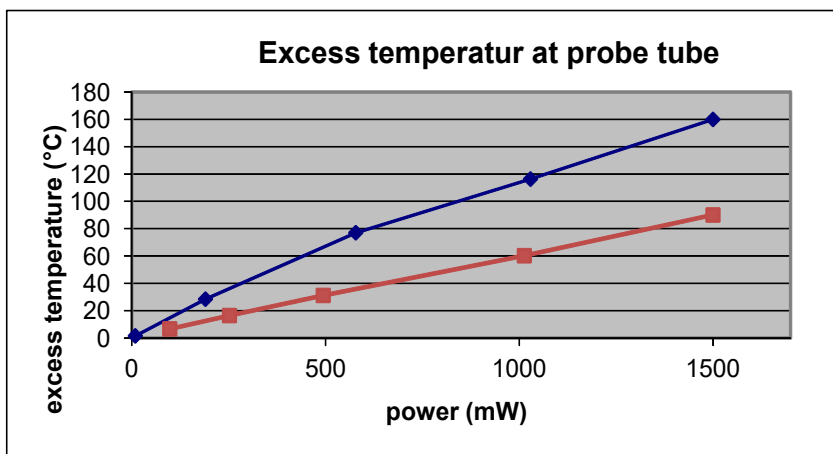

power [mW]	temperature rise [°C]	
	D = 3 mm	D = 6 mm
9	1,5	
98		6,6
190	28,4	
252		16,4
494		31,1
578	77,0	
1013		60,2
1029	116,3	
1500	160	90

Overtemperature at the sensor tube, depending on the power supplied and the sensor tube diameter		
Power P [mW]	D = 3, 4, 5 mm	D ≥ 6 mm
	Self heating Te [°C]	Self heating Te [°C]
10	2	2
25	4	4
50	9	7
100	17	7
200	30	13
300	45	20
500	75	31
650	87	41
750	100	47
1000	133	63
1200	136	71
1500	160	90

Example:

A GTF 101/102 with 6 mm sensor tube is to be used in zone 1 in temperature class T3. Po of the power supply = 500 mW. Which maximum process temperature Tp is allowed?

T3 = 200 °C. Safety distance*1 for T3 = 5K → max. Surface temperature (To) 195 °C

For 500 mW and 6 mm pipes, the self-heating of the probe (Te) is up to 31 °C.

$$T_p = T_o - T_e = 195 \text{ °C} - 31 \text{ °C} = 164 \text{ °C}$$

The sensor must therefore be used in this constellation up to a maximum process temperature of 164 °C

If the same setup is used for Zone 0, the maximum permissible process temperature is:

T3 = 200 °C, for zone 0 only 80%*2 permissible → 160 °C, safety distance*1 for T3 = 5K → maximum permissible surface temperature (To) = 155 °C

self-heating of the temperature sensor is 31 °C

$$T_p = T_o - T_e = 155 \text{ °C} - 31 \text{ °C} = 124 \text{ °C}$$

For zone 0, the sensor can thus be used in this constellation up to a maximum process temperature of 124 °C

The same probe for use in dust environment (with dust deposition <5mm) with an ignition and glow temperature of 200 °C is obtained:

To is max. $2/3^{*3}$ of the ignition temperature = 133 °C

To is glowing temperature - 75 °C*3 = 125 °C

The lower temperature is taken for To → To = 125 °C

self-heating of the temperature sensor is 31 °C

$$T_p = T_o - T_e = 125 \text{ °C} - 31 \text{ °C} = 94 \text{ °C}$$

For thicker layers the max. permissible surface temperature*3 decreases further.



Be sure to take into account the safety distances given by the different standards and regulations.

*1: EN60079-0:2012, Pkt. 26.5.1.3, *2: EN1127-1:2011, Pkt. 6.4.2, *3: EN60079-14, Pkt. 5.6.3

4.2 Permissible ambient temperatures and neck pipe

4.2.1 For Types GTF 101-Ex-i-... and GTF 102-Ex-i-...		
Temperature class / max. Surface temperature	Zone 0, 20	Zone 1, 2, 20, 21
T6 / T80°C	$-20^{\circ}\text{C} \leq T_a \leq +60^{\circ}\text{C}$	$-20^{\circ}\text{C} \leq T_a \leq +60^{\circ}\text{C}$
T5..T1 / >T100°C	$-20^{\circ}\text{C} \leq T_a \leq +60^{\circ}\text{C}$	$-20^{\circ}\text{C} \leq T_a \leq +80^{\circ}\text{C}$
4.2.2 For Types GTF 101-Ex-e-... and GTF 102-Ex-e-...		
Temperature class / max. Surface temperature	Zone 0, 20	Zone 1, 2, 20, 21
T6..T1 / $\geq T80^{\circ}\text{C}$		$-20^{\circ}\text{C} \leq T_a \leq +60^{\circ}\text{C}$

The ambient temperatures for the cable sleeve and cable must be strictly adhered to.

At higher or very low process temperatures, heat or coolant reflux may occur from the process, whereby the permissible ambient temperature can be exceeded or fallen below.

At process temperatures above 100 ° C or below -50 ° C, the probe must therefore have a correspondingly large neck pipe length. GTF 101-Ex must have a sufficient distance from the compression fitting to the sleeve at temperature being kept above 100 ° C or below -50 ° C. For this purpose, an additional tubular sleeve is provided as a stop for the neck length

Recommendation for minimum necessary extension tube lengths with good ventilation:

- Measuring temperatures less than -50 °C => extension tube length 50 - 100 mm
- Measuring temperatures up to 250 °C => extension tube length 50 - 100 mm
- Measuring temperatures up to 400 °C => extension tube length 100 - 200 mm
- Measuring temperatures above 400 °C => extension tube length 200 mm or long



The above guideline values are only indicative and may vary greatly depending on the installation. Observe the maximum ambient temperatures (chapter 4.2) in the installation.

5 Installations instruction

5.1 Connection assignment for Pt100 and Pt1000

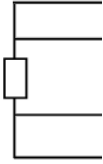
Circuit diagram	wire colour		
	Silicone cable	PVC cable	Teflon cable
	blue	brown	blue
	blue	white	blue
	white	green	white
	white	yellow	white



core wire colours may vary

In these cases, corresponding information will be provided together with the probe

5.2 Connection assignment for thermocouple type K

wire colours: g reen = plus
 white = minus



core wire colours may vary

In these cases, corresponding information will be provided together with the probe

5.3 Cable and conductor gland (CCG)

From the factory side the intermediate support of CCG was glued to the ferrule. Forcibly removing or dissolving the intermediate connecting piece is not allowed (Torque > 3.75 Nm).

The pressure screw of the CCG is to be periodically checked for leaks and retightened if necessary. Additions or changes to the guide elements are not allowed.

6 Specification

Measuring range:	Pt100/Pt1000 without neck tube:	-50 ... +100 °C
	Pt100 with neck tube:	-200 ... +600 °C
	Pt1000 with neck tube:	-70 ... +600 °C
	Thermocouple without neck tube:	-50 ... +100 °C
	Thermocouple with neck tube:	-200 ... +900 °C

Sensor elements:	<ul style="list-style-type: none"> • Mineral-insulated resistance thermometer Pt100, class B, 4-wire • Mineral-insulated resistance thermometer Pt1000, class B, 4-wire • Mineral-insulated thermocouple type K
-------------------------	--

Probe tubes:	<p>Stainless steel thread and probe tube (1.4404, 1.4435, 1.4571, Inconel 600, etc.) Standard version:</p> <p>GTF 101-Ex without neck tube: FL = 100 mm, D = 6 mm, WS ≥ 1,0 mm with neck tube: FL = 100 mm, D = 6 mm, WS ≥ 1,0 mm, HL = 50 mm</p> <p>GTF 102-Ex without neck tube: Thread G ½"A, FL = 100 mm, D = 6 mm, WS ≥ 1,0 mm with neck tube: Thread G ½"A, FL = 100 mm, D = 6 mm, WS ≥ 1,0 mm, HL = 50 mm, HD = 8 mm</p>
---------------------	--

Probe sleeve: Stainless steel (1.4301, etc.)

Cable and conductor gland: Material: polyamide, sealing ring: NBR, IP 68 - 10 bar,
Ambient temperature: max.: -20 ... +80 °C

Connection cable: for Pt100 or Pt1000:

- Silicone cable: 4 x 0.14 mm²
max. ambient temperature: -20 ... +180 °C
connection data: Ci ≤ 100 pF / m, Li ≤ 1 μH / m
- PVC cable: 4 x 0.14 mm²
max. ambient temperature: -20 ... +70 °C
connection data: Ci ≤ 100 pF / m, Li ≤ 1 μH / m
- Teflon cable: 4 x 0.14 mm²
max. ambient temperature: -20 ... +250 °C
connection data: Ci ≤ 100 pF / m, Li ≤ 1 μH / m

for thermocouple type K:

- Silicone compensation cable: 2 x 0.22 mm²
max. ambient temperature: -20 ... +180 °C
connection data: Ci ≤ 200 pF / m, Li ≤ 2 μH / m

Possible components (not always applicable for all ignition protection classes and Ex zones)

Probe tube diameter: 3, 4, 5, 6, 8 mm

*Comment: with diameter = 3 mm: Minimum probe tube length is 60 mm,
the probe is offset 3 to 6 mm*

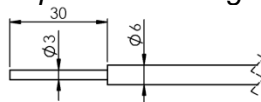

Extension tube diameter: 6 or 8 mm

Comment: Extension tube lengths up to 50 mm are also designed with a tube diameter of 6 mm with a probe tube diameter of 6 mm. With greater lengths, and/or with a probe tube diameter of 8 mm, the standard diameter is 8 mm.

Thread type: G, R, NPT, M - external thread

Thread size: 1/8", 1/4", 3/8", 1/2", 3/4", 10x1, 12x1.5, 14x1.5, 16x1.5, 18x1.5

Sensor elements: Pt 100, Pt 1000, thermocouple type K

6.1 Dimensions

GTF 101-Ex-... without neck tube

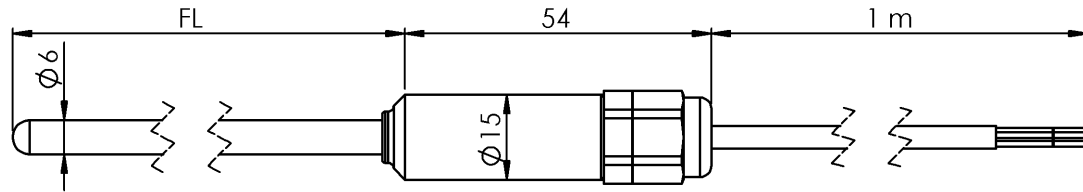

b.) GTF 101-Ex-... with neck tube (insertion stop)

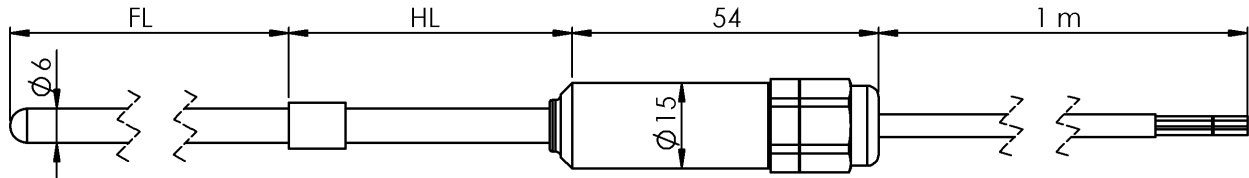

c.) GTF 102-Ex-... without neck tube

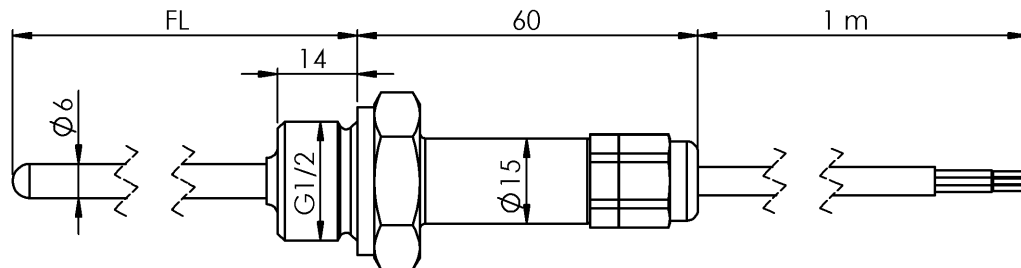

d.) GTF 102-Ex-... with neck tube

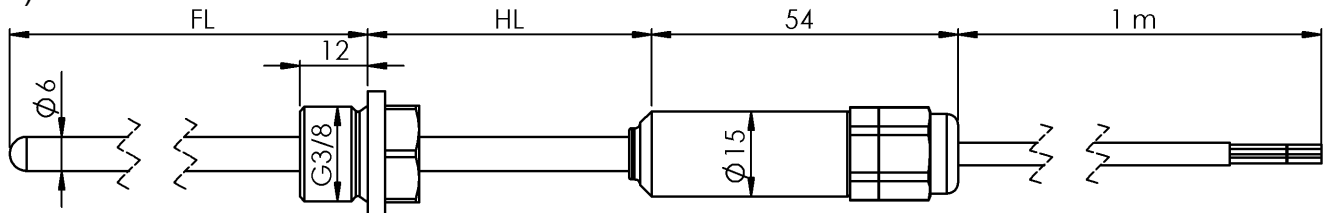

7 Decommissioning, reshipment and disposal

7.1 Reshipment



All devices returned to the manufacturer have to be free of any residual of measuring media and other hazardous substances. Measuring residuals at housing or sensor may be a risk for persons or environment.



Use an adequate transport package for reshipment, especially for fully functional devices. Please make sure that the device is protected in the package by enough packing materials.

7.2 Disposal instructions



The device must not be disposed in the unsorted municipal waste!
Send the device directly to us (sufficiently stamped), if it should be disposed.
We will dispose the device appropriate and environmentally sound.

8 Ordering information

8.1 Ordering code for GTF 101-Ex-... probes

Ordering information for GTF 101-Ex ... Probes

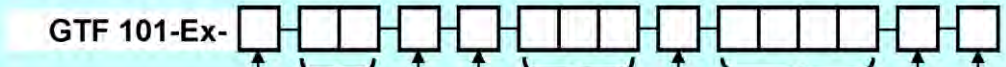

- Protection type:**
e Gas: increased safety, encapsulation (em)
 - only permitted for zone 1 and 2
 Dust: encapsulation (mb)
 - only permitted for zone 21 and 22
i intrinsic safety
- Potentially explosive atmospheres:**
 Gases:
 00 zone 0
 01 zone 1 and zone 2
 Dusts:
 20 zone 20
 21 zone 21 and zone 22
- Sensor-element:**
P Pt100
T Pt1000
K Thermocouple type K
- Neck tube: (length till tube sleeve for depth stop)**
K without neck tube (for -50 °C ≥ T ≤ 100 °C)
M with neck tube (please refer to note below)
- Neck tube length:**
 xxx length in mm
 e.g. 050 (= standard length)
- Probe tube diameter:**
 x 3, 4, 5, 6 or 8 mm
Hint:
 - observe for D = 3 mm:
 • minimum probe length is 60 mm
 • the probe diameter is reduced,
 tube top D = 3 mm (for approx. 30 mm) afterwards D = 6 mm
- Probe length (fitting length):**
 xxxx length in mm
 e.g. 0100 (= 100 mm)
- Cable length: (4-wire)**
 x length in m
 e.g. 1 (= 1 m)
- Cable type:**
S silicone cable
P PVC cable (only available for sensor = Pt100 / Pt1000)
T teflon cable (only available for sensor = Pt100 / Pt1000)

Notify for ambient temperature:
intrinsic safety type

zone 0, 20:	-20 °C ... +60 °C
zone 1, 2, 21, 22:	-20 °C ... +80 °C (+60 °C bei T6)
type with increased safety	
zone 1, 2, 21, 22:	-20 °C ... +60 °C

Recommended min. neck tube length according max. meas. range:

Neck tube construction:	measuring range:	
	Pt 100 a. type K	Pt 1000
- without neck tube	-50 ... +100 °C	-50 ... +100 °C
- neck tube above 50 mm	-200 ... +250 °C	-70 ... +250 °C
- neck tube above 100 mm	-200 ... +400 °C	-70 ... +400 °C
- neck tube above 200 mm	-200 ... +600 °C	-70 ... +600 °C

For reference only! The length should be selected so that the max. specified ambient temperature of the cable sleeve is not exceeded in your installation situation.

Ordering example: GTF 101-Ex for protection type "i", Ex-zone 21, with Pt100, neck tube length: 50 mm, probe diameter: 6 mm, probe length: 200 mm, cable length: 3 m, silicone cable



8.2 Ordering code for GTF 102-Ex-... probes

Ordering information for GTF 102-Ex ... Probes

GTF 102-Ex-

Protection type:
 e Gas: increased safety, encapsulation (em)
 - only permitted for zone 1 and 2
 Dust: encapsulation (mb)
 - only permitted for zone 21 and 22
 i intrinsic safety

Potentially explosive atmospheres:
 Gases:
 00 zone 0
 0A zone 0/1 probe tube in zone 0 and cable sleeve in zone 1
 01 zone 1 and zone 2
 Dusts:
 20 zone 20
 2A zone 20/21 probe tube in zone 20 and cable sleeve in zone 21
 21 zone 21 and zone 22

Sensor-element:
 P Pt100
 T Pt1000
 K Thermocouple type K

Size of screw thread: *Comment*
 00 without thread *not suitable for zone isolation!*
 11 G 1/8" *not suitable for zone isolation!*
 12 G 1/4" *only with D = 6 mm suitable for zone isolation!*
 13 G 3/8" } G-screw thread
 14 G 1/2"
 15 G 3/4"
 22 M10x1 *not suitable for zone isolation!*
 23 M12x1.5 *only with D = 6 mm suitable for zone isolation!*
 24 M14x1.5 } M-screw thread
 25 M16x1.5
 26 M18x1.5
 other threads (e.g. NPT) on request

Neck tube:
 K without neck tube (for -50 °C ≤ T ≤ 100 °C)
 M with neck tube (please refer to note below)

Neck tube length:
 xxx length in mm
 e.g. 050 (= standard length)

Probe tube diameter:
 x 3, 4, 5, 6 or 8 mm
Hint:
 - for zone 0/1, 20/21 (= zone isolation) only 6 mm or 8 mm available
 - observe for D = 3 mm:
 • minimum probe length is 60 mm
 • the probe diameter is reduced, tube top D = 3 mm (for approx. 30 mm) afterwards D = 6 mm

Probe length (fitting length):
 xxxx length in mm
 e.g. 0100 (= 100 mm)

Cable length: (4-wire)
 x length in m
 e.g. 1 (= 1 m)

Cable type:
 S silicone cable
 P PVC cable (only available for sensor = Pt100 / Pt1000)
 T teflon cable (only available for sensor = Pt100 / Pt1000)

Notify for ambient temperature:
intrinsic safety type
 zone 0, 20: -20 °C ... +60 °C
 zone 0/1, 1, 2: -20 °C ... +80 °C (+60 °C bei T6)
 zone 20/21, 21, 22: -20 °C ... +80 °C (+60 °C bei T<100°C)
type with increased safety
 zone 1, 2, 21, 22: -20 °C ... +60 °C

Recommended min. neck tube length according max. meas. range:
 Neck tube construction: measuring range:

	Pt 100 a type K	Pt 1000
- without neck tube	-50 ... +100 °C	-50 ... +100 °C
- neck tube above 50 mm	-200 ... +250 °C	-70 ... +250 °C
- neck tube above 100 mm	-200 ... +400 °C	-70 ... +400 °C
- neck tube above 200 mm	-200 ... +600 °C	-70 ... +600 °C

For reference only! The length should be selected so that the max. specified ambient temperature of the cable sleeve is not exceeded in your installation situation.

Ordering example: GTF 102-Ex for protection type "i", Ex-zone 1, with Pt100, thread: G 1/2", neck tube length: 50 mm, probe diameter: 6 mm, probe length: 200 mm, cable length: 3 m, silicone cable

GTF 102-Ex- **i** **0** **1** **P** **1** **6** **M** **0** **5** **0** **6** **0** **2** **0** **0** **3** **S**

9 EU - Declaration of conformity

GREISINGER

Member of GHM GROUP



EU-KONFORMITÄTSERKLÄRUNG EU-DECLARATION OF CONFORMITY

GHM GROUP - Greisinger | GHM Messtechnik GmbH | Hans-Sachs-Str. 26 | 93128 Regenstauf | GERMANY

Dokument-Nr. / Monat.Jahr: **1039 / 09.2017**
Document-No. / Month.Year:

Wir erklären hiermit unter alleiniger Verantwortung, dass die folgenden Produkte konform sind mit den Schutzziele der Richtlinie des Europäischen Parlaments:

We declare herewith under our sole responsibility that the following products are in compliance with the protection requirements defined in the European Council directives:

Produktbezeichnung: **GTF 101-Ex-..., GTF 102-Ex-..., GTF 103-Ex-...,
 GTF 111-Ex-..., GTF 112-Ex-...**
Product identifier:

Produktbeschreibung: **Temperatursensor
 (Temperature probe)**
Product description:

Die Produkte entsprechen den folgenden Europäischen Richtlinien:

The products conforms to following European Directives:

Richtlinien / <i>Directives</i>	
2014/30/EU	EMV Richtlinie / <i>EMC Directive</i> (nur für GTF 103 mit integriertem Kopftransmitter / <i>only for GTF 103 with integrated head transmitter</i>)
2014/34/EU	ATEX / <i>ATEX</i>
2011/65/EU	RoHS / <i>RoHS</i>

Angewandte harmonisierte Normen oder angeführte technische Normen:

Applied harmonized standards or mentioned technical specifications:

Harmonisierte Normen / <i>harmonized standards</i>	
EN 61326-1 : 2013	Allgemeine EMV Anforderungen / <i>General EMC requirements</i>
EN 61326-2-3 : 2013	Besondere EMV Anforderungen / <i>Particular EMC requirements</i>
EN 60079-0 : 2014 (EN 60079-0 : 2012 + A11:2013)	Allgemeine ATEX Anforderungen / <i>General ATEX requirements</i>
EN 60079-7 : 2015	Geräteschutz durch erhöhte Sicherheit "e" / <i>Protection by increased safety "e"</i>
EN 60079-11 : 2012	Geräteschutz durch Eigensicherheit "i" / <i>Protection by intrinsic safety "i"</i>
EN 60079-18 : 2015	Geräteschutz durch Vergusskapselung "m" / <i>Protection by encapsulation "m"</i>
EN 60079-26 : 2015	Geräteschutzniveau (EPL) Ga / <i>Equipment Protection Level (EPL) Ga</i>
EN 60079-31 : 2014	Staubexplosionsschutz durch Gehäuse "t" / <i>Dust ignition protection by enclosure "t"</i>
EN 50581 : 2012	Beschränkung der gefährlichen Stoffe / <i>Restriction of hazardous substances</i>

Diese Erklärung wird verantwortlich für den Hersteller abgegeben durch:

The manufacturer is responsible for the declaration released by:

Roland Bäuml

Standortleiter
Site Director

Regenstauf, 22. September 2017

Diese Erklärung bescheinigt die Übereinstimmung mit den genannten Harmonisierungsrechtsvorschriften, beinhaltet jedoch keine Zusicherung von Eigenschaften

This declaration certifies the agreement with the harmonization legislation mentioned, contained however no warranty of characteristics.

Members of GHM GROUP: **GREISINGER** | **HONSBURG** | **Martens** | **IMTRON** | **Nelta**

10 EU - Type Examination Certificate



EU - Type Examination Certificate

- (1)
- (2) Equipment and protective systems intended for use in potentially explosive atmospheres – Directive 2014/34/EU
- (3) EU - Type Examination Certificate Number
- EPS 16 ATEX 1 005 X** **Revision 2**
- (4) Equipment: Temperature sensor type GTF 1xx-Ex-...
- (5) Manufacturer: GHM Messtechnik GmbH
- (6) Address: GHM GROUP - Greisinger
GHM Messtechnik GmbH
Hans-Sachs-Str. 26
93128 Regenstauf
Germany
- (7) This equipment and any acceptable variation thereto are specified in the annex to this certificate and the documentation therein referred to.
- (8) Bureau Veritas Consumer Products Services Germany GmbH, notified body No. 2004 in accordance with Article 21 given in the Directive 2014/34/EU of the European Parliament and of the Council of 26 February 2014, certifies that this equipment has been found to comply with the essential health and safety requirements relating to the design and construction of equipment and protective systems intended for use in potentially explosive atmospheres, given in Annex II of the Directive. The examination and test results are recorded in the confidential documentation under the reference number 15TH0210.
- (9) Compliance with the essential health and safety requirements has been assured by compliance with:
- | | |
|----------------------------|------------------|
| EN 60079-0:2012 + A11:2013 | EN 60079-7:2015 |
| EN 60079-11:2012 | EN 60079-18:2015 |
| EN 60079-26:2015 | EN 60079-31:2014 |
- (10) If the sign "X" is placed after the certificate number, it indicates that the equipment is subject to special conditions for safe use specified in the annex to this certificate.
- (11) This EU - Type Examination Certificate relates only to the design and examination of the specified equipment in accordance with Directive 2014/34/EU. Further requirements of this Directive apply to the manufacture of this equipment and its placing on the market. Those requirements are not covered by this certificate.

Page 1 of 3

Certificates without signature and seal are void. This certificate is allowed to be distributed only if not modified. Extracts or modifications must be authorized by Bureau Veritas Consumer Products Services Germany GmbH. EPS 16 ATEX 1 005 X, Revision 2.



(12) The marking of the equipment shall include the following:

 II 1G Ex ia IIC T6 Ga
II 1D Ex ia IIIC T80°C Da IP65

or

 II 1/2G Ex ia IIC T6 Ga/Gb
II 1/2D Ex ia IIIC T80°C Da/Db IP65

or

 II 2G Ex ia IIC T6 Gb
II 2D Ex ia IIIC T80°C Db IP65

or

 II 2G Ex eb IIC T6 Gb
II 2D Ex tb IIIC T80°C Db IP65

or

 II 2G Ex eb mb IIC T6 Gb
II 2D Ex mb IIIC T80°C Db IP65



Certification department of explosion protection

Nuremberg, 2017-08-28



H. Schaffer

Page 2 of 3

Certificates without signature and seal are void. This certificate is allowed to be distributed only if not modified. Extracts or modifications must be authorized by Bureau Veritas Consumer Products Services Germany GmbH. EPS 16 ATEX 1 005 X, Revision 2.



Annex

(13)

(14) **EU - Type Examination Certificate EPS 16 ATEX 1 005 X****Revision 2**(15) Description of equipment:

The temperature sensors GTF 1xx-Ex... are designed as build-in sensors for use in potentially explosive atmospheres of all zones.

Electrical data:

The maximum permissible electrical parameters (current, power) are determined by the temperature class of each sensor, see user manual.

Maximum electrical data for the increased safety versions: $U = 4 \text{ V}$, $I = 10 \text{ mA}$

(16) Reference number: 15TH0210(17) Special conditions for safe use:

Maximum ambient temperature range:

- 20 °C to +60 °C (increased safety)
- 20 °C to +80 °C (intrinsic safety)
- 20 °C to +50 °C (intrinsic safety with 4-20 mA output)

The maximum short-circuit current of the increased safety variants shall be protected in an appropriate manner: 500 mA (for Pt100, Pt1000), 100 mA (for TC type K). See user manual too.

The temperature sensor shall only be connected to power supplies / controllers which are designed and approved for the operation of passive resistance sensors. The power supplies / controllers shall provide a low safety- or protection voltage. The power supplies / controllers shall have a, the method of connection of the thermometer corresponding port. The electrical characteristics and the associated standard for the thermometer shall be observed.

(18) Essential health and safety requirements:

Met by compliance with standards.



Certification department of explosion protection

Nuremberg, 2017-08-28

Page 3 of 3

Certificates without signature and seal are void. This certificate is allowed to be distributed only if not modified. Extracts or modifications must be authorized by Bureau Veritas Consumer Products Services Germany GmbH. EPS 16 ATEX 1 005 X, Revision 2.