

pH- and ORP-Panelmeter pH 9648

pH- and ORP measurement with standard electrodes

Features

- LED-Display 14.2 mm rot
- pH-value -1.00 ... +15.00 pH
ORP -1500 ... +1500 mV
- 1-point- or 2-point calibration of the electrodes
- Temperature compensation with RTD; Pt100 or Pt1000 Sensor
- Max. 4 alarm outputs relay SPDT or electronic
- Isolated analog output
0/4 ... 20 mA or 0/2 ... 10 V DC for pH/ORP
or 2 isolated passive analog outputs 4...20 mA for pH/ORP and temperature.
Analog start and final value free programmable
- Front protection IP65



DIN 96x48 mm

General information

The pH-and ORP-Panelmeter pH9648 is suitable for pH and ORP measurement in food technology, chemistry within pharmaceutical and sewage-water technology. The pH9648 works with all common pH- and ORP electrodes. It is recommend to connect the Impedance-Converter pH40 for cable length > 5 m.

Short information

Programming	Parameters are programmed via front side membrane keypad
Alarm outputs	Switching performance is programmable as minimum or maximum function. Actuation of the outputs are displayed.
Analog output active	Proportional to the pH- or ORP-signal an isolated analog signal 0 ... 20 mA / 0 ... 10V DC or 4 ... 20 mA / 2 ... 10 V DC can be generated. The output changes automatically from current signal to voltage signal, depending on burden. ($\geq 500 \Omega \rightarrow$ voltage).
Analog output passive	Proportional to the pH- or ORP-signal and the temperature, an isolated analog signal 4 ... 20mA will be generated.

Technische Daten

Power supply

Supply voltage	: 230 V AC $\pm 10\%$; 115 V AC $\pm 10\%$; 24 V AC $\pm 10\%$ or 24 V DC $\pm 15\%$
Power consumption	: max. 3.5 VA, with analog output 5 VA
Operating temperature	: -10 ... +55 °C (14 ... 131 °F)
Rated voltage	: 250 V~ acc. to VDE 0110 between input/output/supply voltage degree of pollution 2, over-voltage category III
Test voltage	: 4 kV=, between input/output/supply voltage
CE - conformity	: EN55022, EN60555, IEC61000-4-3/4/5/11/13

Input

pH/ORP

Measuring range	: -1.00 ... +15.00 pH or. -1500 ... +1500 mV
Input resistance	: $> 10^{12} \Omega$
Input current	: $< 10^{-12} \text{ A}$
Accuracy	: 0.2 % of the actual measuring range, ± 2 Digit
Temp. coefficient	: $< 100 \text{ ppm/K}$
Conv. rate	: approx. 2/s
Calibration limits pH	: electrode zero point 4.00 ... 10.00pH slope 40.0 ... 70.0 mV/pH

ORP setup : $\pm 200 \text{ mV}$

Calibration modes

- **1- or 2-point-calibration**
- Buffer selection possible :
 - Schott: technical buffer with nominal values
4.00/7.00/10.00 in range 0 ... 40 °C
 - WTW; technical buffer with nominal values
4.01/7.00 in range 0...95 °C/10.00 in range 0...90 °C
 - Ingold (Mettler Toledo) technical buffer with nominal values
4.01/7.00/9.21 in range 0 ... 95 °C
 - DIN 19266 buffer with the nominal values
4.01/6.87/9.18 in range 0 ... 95 °C
 - or manual buffer data in each range
- **Data** entering the value for zero point and slope
- **ORP** offset

Temperature

Temperature sensor	: RTD, Pt100 or Pt1000, (2- or 3-wire connection)
Unit	: programmable °C, °F
Measuring range	: - 40.0 ... +160.0 °C (- 40.0 ... 320.0 °F)
Accuracy	: $\pm 0.1\%$, ± 1 Digit
Temp. coefficient	: $< 50 \text{ ppm/K}$
Linearization error	: $\pm 0.1\%$

Transmitter supply : U_0 appr. 24 V DC, R_i appr. 150 Ω , max. 50 mA (25 mA with 4 relay outputs)

Display

Indicating range	: see measuring ranges
Parameter display	: LED 2-digit red, 7 mm (parameter - and actuation display)

Output

Relay	: SPDT $< 250 \text{ V AC}$ $< 250 \text{ VA}$ $< 2 \text{ A}$, $< 300 \text{ V DC}$ $< 50 \text{ W}$ $< 2 \text{ A}$
Electronic	: Transistor, $< 35 \text{ V AC/DC}$, max.100 mA, short-circuit protection
Active analog output	: 0/4 ... 20 mA burden $\leq 500 \Omega$; 0/2 ... 10 V burden $> 500 \Omega$, isolated, automatic output changing (burden dependent)
Passive analog output	: 4...20 mA, ext. burden = $R_A[\Omega] \leq (\text{supply voltage}-5 \text{ V}) / 0.02 \text{ A}$; Supply 5 ... 30 V DC, supply error 0.005 %/V

Accuracy : 0.1 %; TK 0.01 %/K

Panel case

Dimensions	: DIN 96x48 mm, material PA6-GF; UL94V-0
Weight	: max. 390 g
Terminals	: clamp terminals, 2.5 mm ² single wire, 1.5 mm ² flexible wire, AWG14
Protection	: Front IP65, terminals IP20, finger safe acc. to BGV A3

Connection diagrams

Terminal strip A

Inputs for pH-/ORP-electrodes and RTD-sensor. Connection examples see page 4

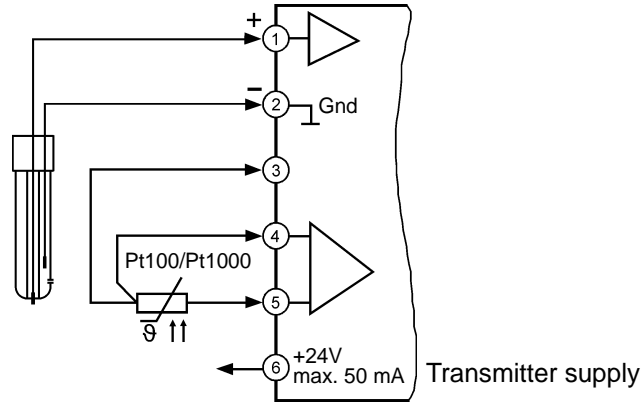

Terminal strip B (varies with version)

2 alarm outputs

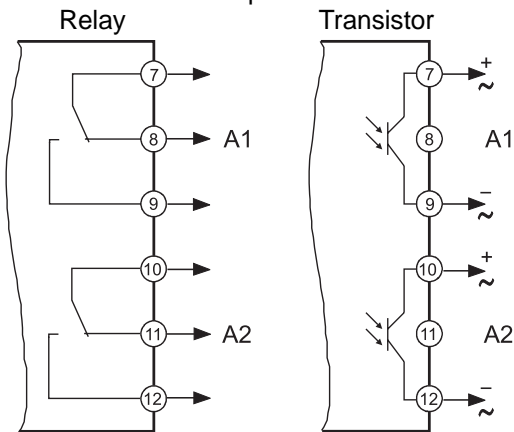

Terminal strip C (varies with version)

2 alarm outputs

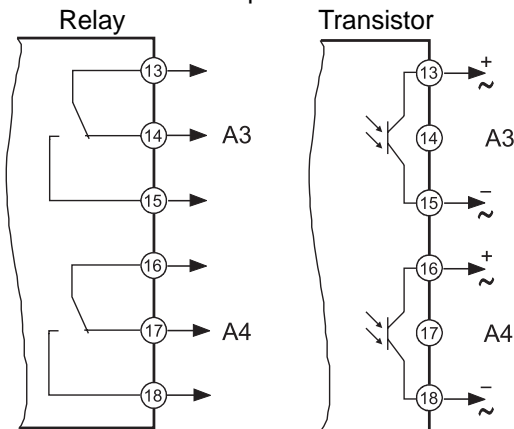

Analog output
AO

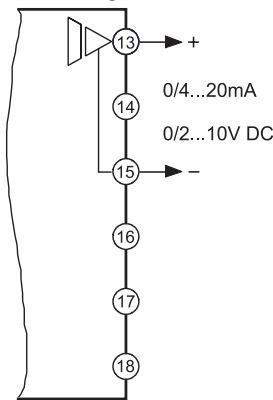

2 Analog outputs passive
2A1 (pH/ORP), 2A2 (temperature)

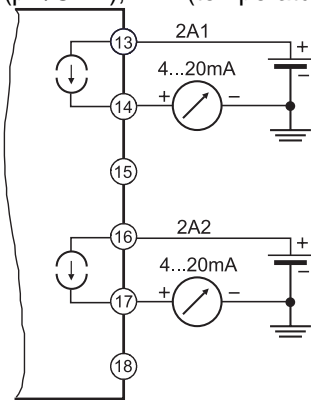

Terminal strip D supply voltage (varies with version)

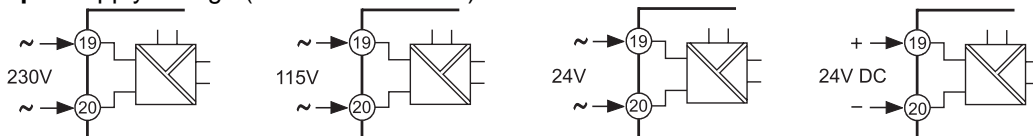

Connection examples

pH-combination electrode with integr. RTD sensor

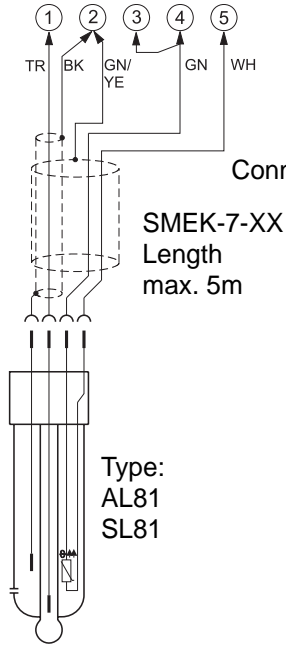

pH-/ORP-combination electrode with ext. RTD sensor

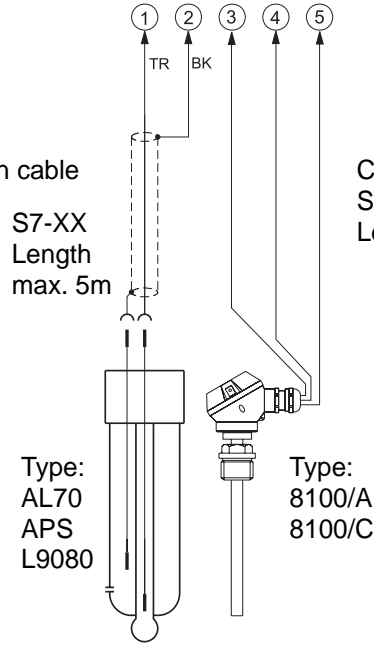

pH-combination electr. with SMEK-plug and Impedance-Converter pH40-1

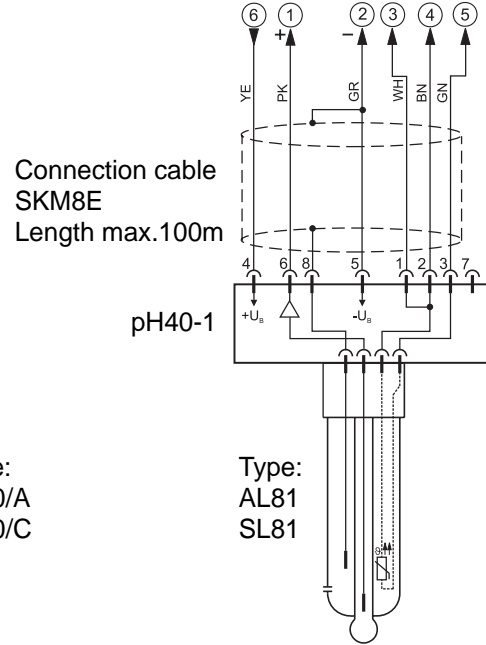

Legend of colours

BK black, **BL** blue, **BN** brown, **GN** green, **GN/YE** green/yellow, **GR** grey, **PK** pink, **TR** transparent, **WH** white, **YE** yellow. Not used cables can be cut off.

Dimensions

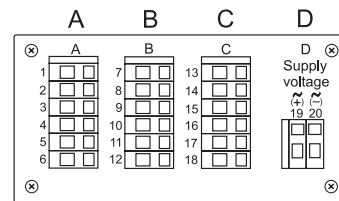
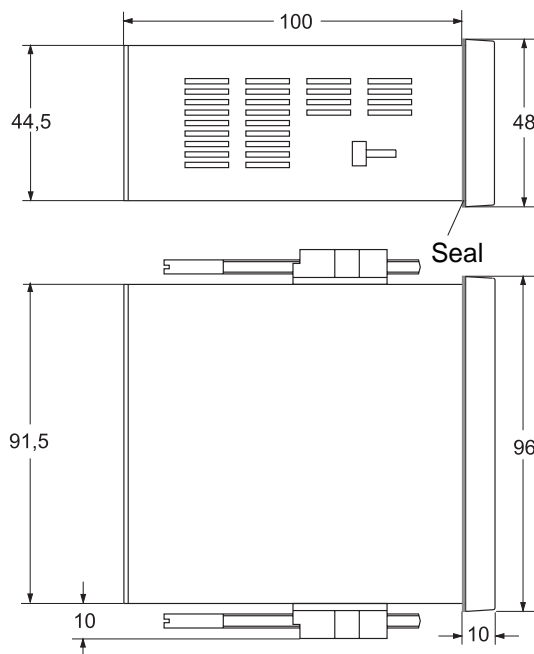

Terminal strip position

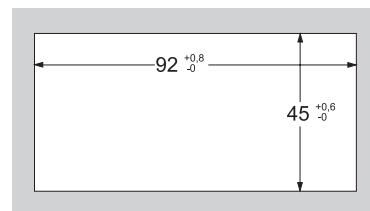

Panel cut-out
acc. to DIN 43700-96x48

Controls and indicators

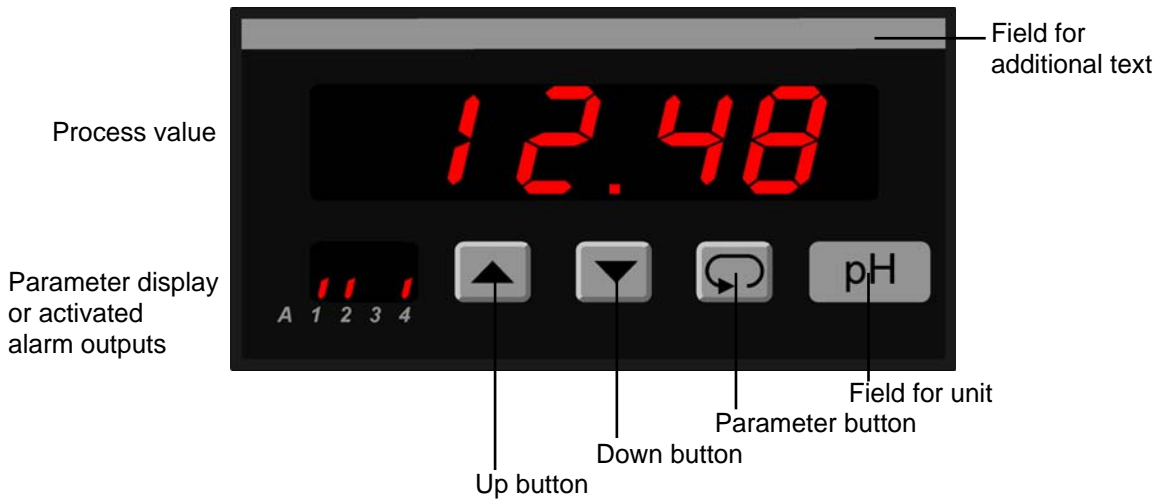

Description

Operation of the device is arranged in 2 levels. The requested parameter can be called by the button . For selection within a parameter or for entering data, use buttons and .

Button combinations:

- + one parameter back.
- + setting parameter to zero or minimum value.

After turn on the supply voltage, the device initialize itself and is operating in the Working level. Temperature can be called back, set points of the alarm outputs can be programmed and the electrode can be calibrated.

Pressing the button for more than 2 seconds, activates the **Configuration level**. Now all the parameters which define the function of the device can be programmed. E.g. the measuring input, switching performance of alarm outputs and the analog output signal. After finishing the configuration or when no button was pushed for more than 2 minutes, the program returns to the working level. Leaving the configuration level is possible at any time by pressing the button for more than 2 seconds.

Error messages:

- Display flashes** If the measured signal is more than 3 % outside of the programmed range, the A/D- converter overflows and the display flashes.
If the indicating range exceeds the resolution of the internal A/D-converter the display flashes with 9 9 9 9 or - 9 9 9 9 .
- PE** Reading this message in the parameter display, an parameter failure has been occurred. The display flashes. When pushing one of the buttons, the error code will be deleted and the device is operating with factory settings. Configuration and function of the device must be checked. If the error occurs again, please ship the device to factory for repair service.
- bELIPH** The difference between calibration points 1 and 2 is below 1 pH. The data input for point 2 can be reiterated with button .
- REPL** The electrode should be displaced in the nearest future. May be the electrode zero-point exceeds the tolerance from 6 ... 8 pH or the slope exceeds the tolerance of 53 ... 60 mV/pH. The calibration limit will not exceeded. It is possible to continuo the calibration with button .
- Error** Calibration error: e.g. the calibration limits go across with wrong connection, time limit or the temperature range of a used buffer solution. If necessary, reiterate the calibration or replace the electrode. After the actuation of button , the parameter 6 "Pc" (see page 6) will be displayed.
- Loc** Parameter lockout active (see configuration page 12).

Notes to representation

Parameter is only displayed when configured











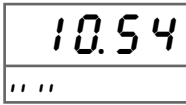

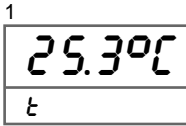

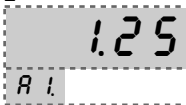



Parameter is only displayed when feature is included (see order code)

⚠ Please Note:

All parameters can be called if they are not blocked by other programmed parameters and if they are available. **Factory settings** are shown in the display.

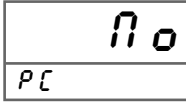
Device configuration see page 10

Working level

Button	Display	Description
		Actual process value pH or ORP Alarm-output indication (if included and activated)
		
		1 Process value of the medium-temperature
		
		2 Setpoint alarm output A1 (for pH/ORP or Temperature) Setting possible in the programmed measuring range with buttons  and  .
		
		5 Setpoint alarm output A4 (for pH/ORP or Temperature) Setting possible in the programmed measuring range with buttons  and  .
		
		If the parameter 29 for "o r P" (ORP) was selected continue with parameter 26 "r C" pH-calibration Selection of the calibration mode No calibration no → if no was selected, back to the process display 1- or 2-point-calibration see parameter 7 "P b" page 7. CAL → Selection of the pH-value from a used buffer solution automatically or manual input of a standardised buffer. Data calibration see parameter 24 "P D ." page 9 d R t R → manual input of the zero point and slope of the used electrode acc. to the protocol. Selection with button  and  .
		





continue
page 7



Button Display Description





1- or 2-point-pH-calibration

7

  Selection of the buffer set.
Schott → Buffer with the nominal value* (Schott)
 4,00/7,00/10,00 at 0...40 °C
WTW → Buffer with the nominal value* (WTW)
 4,01/7,00 at 0...95 °C/10,00 bei 0...50 °C
Inbod → Buffer with the nominal value* (Mettler-Toledo)
 4,01/7,00/9,21 at 0...95 °C
19266 → Buffer with the nominal value* (DIN-Puffer)
 4,01/6,87/9,18 at 0...95 °C
nnnn → Manual input of buffer value acc. to a pH-temperature table
 Selection with buttons  and  .
 *Nominal value at 25 °C





8

  Temperature calibration principle if parameter 30 = *Pt 100* or *Pt 1000*
Pt 100 or *Pt 1000* → Automatic calibration see parameter 9
nnnn → Manual input see parameter 10
 Selection with buttons  and  .



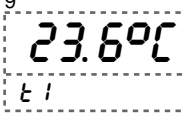



9

  Automatical measurement of the temperature of the 1. pH-buffer solution at selection *Pt 100* or *Pt 1000*.
 Rinse the temp. sensor or the electrode with integr. sensor in mains water, dry the protection sheath with a paper tissue and immerse in the 1. buffer solution. Wait for a constant value in the display. Continue with parameter 11.







10

  Manual input of the temperature of the 1. buffer solution at selection *nnnn*
 Setting possible from -40.0 ... 160.0 °C (-40.0 ... 320.0 °F)
 with buttons  and  .

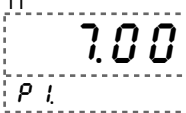





11

  Input of the value of the 1. pH -buffer solution
 Input of the nominal value of the selected buffer set, or the calculated pH value at the displayed temperature, from the pH temperature table
 with buttons  and  (see parameter 7).





12

  If not arranged in parameter 9,
 rinse pH-electrode in mains water, dry the protection sheath with a paper tissue and immerse in the 1. buffer solution. Press button  to start the calibration.



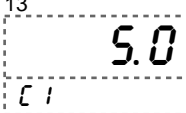























13

  During the calibration the Panelmeter displays the currently measured voltage [mV]. With occasional stirring in the buffer solution, the calibration could be finished earlier. It is possible to stop the calibration with button  .
 Continue with Parameter 6 "*Pt*".



Continue
page 8

Button	Display	Description
	14 t=43 [1]	The calibration of the 1. buffer is finished. the measured time will be displayed. With new electrodes the measured time is lower than 60 s. With older or dirty electrodes the time could be more than 300 s. Error messages see page 5.
		
	15 1P-CAL 2P	<p>1P-CAL → 1-point-calibration. the calibration is finished</p> <p>2P-CAL → 2-point-calibration. A second buffer must be measured</p> <p>Selection with button  and .</p> <p>If "1P-CAL" was selected: continue → result pH-calibration parameter 22 "P0" Error messages see page 5.</p>
		
	16 23.6°C t2	<p>Automatical measurement of the temperature of the 2.pH-buffer solution at selection P t 100 or P t 1000.</p> <p>Rinse the temp. sensor or the electrode with integr. sensor in mains water, dry the protection sheath with a paper tissue and immerse in the 2. buffer solution. Wait for a constant value in the display. Continue with parameter 18.</p>
		
	17 25.3°C t2	<p>Manual input of the temperature of the 2.buffer solution at selection n n n n</p> <p>Setting possible from -40.0 ... 160.0 °C (-40.0 ... 320.0 °F)</p> <p>with buttons  and .</p>
		
	18 4.00 P2	<p>Input of the value of the 2. pH -buffer solution</p> <p>Input of the nominal value of the selected buffer set, or the calculated pH value at the displayed temperature, from the pH temperature table with buttons  and .</p> <p>(See parameter 7).</p>
		
	19 Start [2]	<p>If not arranged in parameter 16, rinse pH-electrode in mains water, dry the protection sheath with a paper tissue and immerse in the 2. buffer solution. Press button  to start the calibration.</p>
		
	20 175.0 [2]	<p>During the calibration the Panelmeter displays the currently measured voltage [mV]. With occasional stirring in the buffer solution, the calibration could be finished earlier. It is possible to stop the calibration with button .</p> <p>Continuo with Parameter 6 "P t".</p>
		
	21 t=43 [2]	The calibration of the 2. buffer is finished. the measured time will be displayed. With new electrodes the measured time is lower than 60 s. With older or dirty electrodes the time could be more than 300 s. Error messages see page 5.
		

Continue
page 9



Button	Display	Description
Result pH-calibration		
↓	²² 7.00 pH	The panelmeter displays the calculated electrode zero-point [pH], based on 25 °C.
↻		
↓	²³ 59.2 pF	The panelmeter displays the calculated slope [mV/pH], based on 25 °C.
↻		

Calibration with manual data input

↓	²⁴ 7.00 pH	Input of the known zero point of the pH-electrode based on 25 °C (pH-value of the electrode at 0 mV). Setting possible from 4.00 ... 10.00 pH with buttons ▲ and ▼ .
↻		
↓	²⁵ 59.2 pF	Input of the known slope of the electrode Setting possible from 40.0 ... 70.0 mV/pH with buttons ▲ and ▼ .
↻		

Calibration ORP offset

↓	²⁶ no rE	Calibration of the ORP electrode no → no offset calibration YES → the offset voltage of the electrode will be measured Selection with buttons ▲ and ▼ .
↻		
↓	²⁷ 22.5°C t	Temperature measuring of the ORP buffer. Rinse the temperature sensor in mains water, dry the protection sheath with a paper tissue and immerse in the buffer solution. Wait for a constant value in the display. This parameter is only be displayed if temperature measurement (parameter 30) Pt100/Pt1000 was selected.
↻		
↓	²⁸ 0 r0	Calibration of the electrode with a ORP buffer. Rinse the temperature sensor in mains water, dry the protection sheath with a paper tissue and immerse in the buffer solution. Set the display value with buttons ▲ and ▼ to the buffer value acc. to the temperature-voltage table. Unit mV.
↻		
	10.54	Back to the process display.

Configuration

Button **Display** **Description** (Display graphic shows factory settings)



Press
2 s

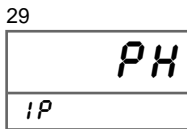

Input signal *PH* or *ORP* (Redox)
Selection with buttons ▲ and ▼ .



Temperature measurement of the medium
Pt 1000 → Measurement with Pt1000 Sensor
Pt 100 → Measurement with Pt100 Sensor
nnnn → Manual temperature-input
Selection with buttons ▲ and ▼ .

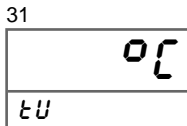

Unit of the temperature measurement
°C or *°F*
Selection with buttons ▲ and ▼ .

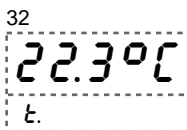

Manual input of the temperature (measurement without sensor).
Setting possible from -40.0 ... 160.0 °C (-40.0 ... 320.0 °F)
with buttons ▲ and ▼ .



Sense correction (only with 2-wire connection)
Setting possible from -9.9 ... 9.9 °C (-17.8 ... 17.8 °F)
with buttons ▲ and ▼ .



Cable-length	Pt100 [°C]	Pt1000 [°C]
2 m	-0.7	-0.1
5 m	-1.8	-0.2
10 m	-3.6	-0.4
25 m	-8.9	-0.9

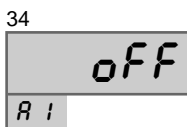

Relating of the alarm function A1
OFF Off
PH / rEd pH or Redox
tEnnP Temperature
Selection with buttons ▲ and ▼ .

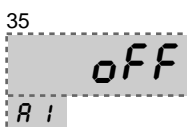

Switching performance A1
Function; *onL* (min); or *onJ* (max)
Selection with buttons ▲ and ▼ .



Continue
page 11

Button	Display	Description (Display graphic shows factory settings)
--------	---------	--

↓	³⁶ 	Setpoint A1 Setting possible in the measuring range with buttons ▲ and ▼ .
---	--	---



↓	³⁷ 	Hysteresis A1 Setting possible from 1 digit ... and value of the measuring range with buttons ▲ and ▼ .
---	--	--

Note: The parameter settings for A2 - A4 have to be configured in the same way.



↓	³⁸ 	Selection of the active analog output $0 - 20$ mA (0 - 10 V DC) or $4 - 20$ mA (2 - 10 V DC). Changing from current to voltage output is load dependent ($\leq 500\Omega$ = current output, $> 500\Omega$ = voltage output) Selection with button ▲ and ▼ .
---	--	---

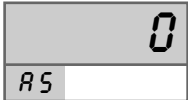

↓	³⁹ 	Active analog output for pH and ORP, start value Setting possible in the measuring range with buttons ▲ and ▼ .
---	--	--



↓	⁴⁰ 	Active analog output for pH and ORP, end value Setting possible in the measuring range with buttons ▲ and ▼ . If $RS > RE$, the output works with a decreasing characteristic.
---	--	---

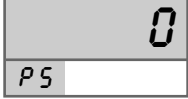

↓	⁴¹ 	Passive analog output for pH and Redox 2A1, start value Setting possible in the measuring range with buttons ▲ and ▼ .
---	--	---















↓	⁴² 	Passive analog output for pH and Redox 2A1, end value Setting possible in the measuring range with buttons ▲ and ▼ . If $PS > PE$, the output works with a decreasing characteristic.
---	--	--

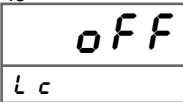

Continue
page 12

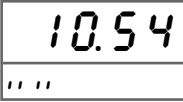

Button	Display	Description (Display graphic shows factory settings)
	⁴³ 	Passive analog output for temperature 2A2, start value Setting possible from -40.0 ... 160.0 °C (-40.0 ... 320.0 °F) with buttons  and  .
	⁴⁴ 	Passive analog output for temperature 2A2, end value Setting possible from -40.0 ... 160.0 °C (-40.0 ... 320.0 °F) with buttons  and  . If $t5 > tE$, the output works with a decreasing characteristic.
	⁴⁵ 	Programming lock <i>oFF</i> : no lock <i>[o]nF.</i> : configuration level locked <i>ALL</i> : all parameters locked <i>[R]L</i> : only for factory settings Selection with buttons  and  .
		Return to the working level

Calibration notes

In practice the characteristic curves of pH electrodes deviate from the ideal curve. For precise measurement it is necessary to calibrate the pH-9648 to the used pH-electrode when setting in operation and afterwards in regular interval times. Standardised pH-buffer solutions can be used to check measuring points of the connected pH-electrode.

Maximum operating values for correct measurement: Zero point 6.0 ... 8.0 pH; span 53.0 ... 59.2 mV/ph.

1-point-calibration:

The pH-electrode will be calibrated only with one buffer solution. The software of the measuring device moves the characteristic curve to the calibration point (see diagram A).

- Practicably if the pH value of the process liquid stays near the buffer solution, no high accuracy is necessary and the temperature doesn't change very much.

2-point-calibration:

The pH-electrode will be calibrated with 2 buffel solutions. The accurate characteristic curve will be recorded. The software considers the deviation to the ideal curve (see diagram B).

- This mode is recommend if the ph value or the temperature of the process solutions heavy vacillates and high accuracy is necessary.

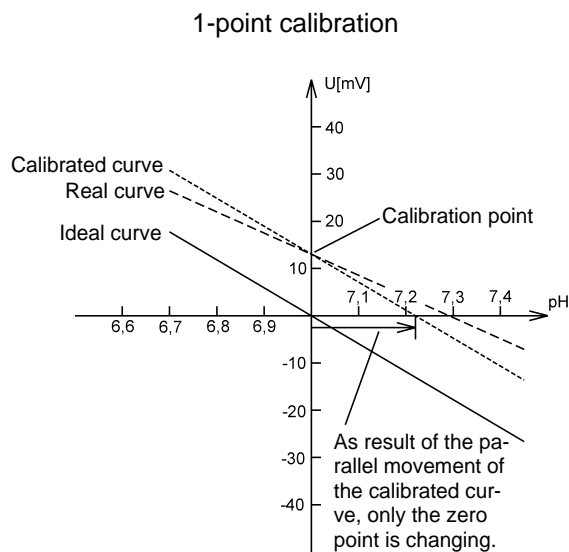

Diagram A

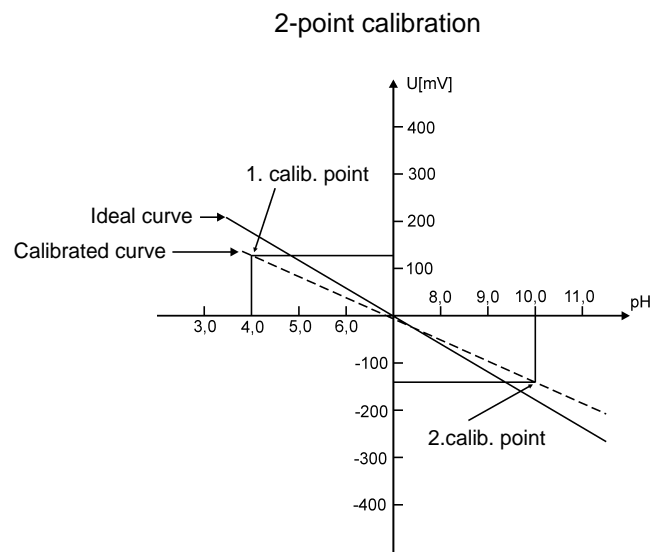

Diagram B

The pH9648 offers several calibration modes

1.) 1- and 2-point-calibration (C R L)

One of the standardised buffers (see page 2, technical data) will be used. Alternatively its possible to enter the buffer value manual.

2.) Data input (d R L R)

The parameters zero point and slope of the used pH-electrode are known and be entered directly into the pH9648.

Required utilities:

- Buffer solutions corresponding to the desired metho of calibration
- Mains water for rinsing the electrodes
- Paper tissues for cleaning the electrodes

Operating Instruction for pH/ORP- electrodes

Delivery and shipping	The electrodes are supplied with a protection cap filled with a 3-mole KCl-solution. This cap prevents a draining of the electrode. Otherwise they lose their function.
Storage	The electrodes should be stored within the temperature range -5 ... +30 °C. Otherwise they can be damaged irreparably, by temperatures under -5 °C. In order to avoid a draining of the electrodes, these should be stored with the associated protective cap. With longer storage time, the level of liquid of the cap is to be examined. A storage time longer than 1 year is not recommendable.
Refreshing	Drained electrodes normally can be regenerated, but they will never achieve the original conditions. Therefore the electrode must be stored in a 3-mole KCl-solution for 24 hours. If the electrode should bring thereafter still no satisfying values, a heating up to 60 ... 80° in a water bath can cleanse a possibly blocked up diaphragm. The electrodes with liquid reference must be filled up.
Preparing for measurement	During adjustment of the cable length, the black insulating of the coax lead must be removed. pH-electrodes have a high internal resistance. Humidity at the connection plug must be avoided (danger; creeping current). Don't touch the contacts of the plug while removing the plug protection cap. Transition resistance leads to an erroneous measurement. Take off the Protection cap and rinse off possible salt incrustations. Electrodes with liquid electrolyte for the reference electrode must be possibly refilled. Electrodes with gel filling may not be opened, protecting covers may not be shifted. If there are some bubbles at the front measuring area, they are removable by shaking the electrode (like a fibre thermometer).
Calibration	In practice the characteristic curves of the pH electrode deviate from the ideal line. For precise measurement it is necessary to calibrate the pH-electrode during commissioning and after regular time intervals. It is common to calibrate the electrode with a 2-point-calibration for zero-point and the slope. The value of the buffer-solution should be nearly at the measuring value of the process. For higher precision it is recommended to heat the solution to the process temperature. Alkaline solutions change their value while picking up CO ₂ from the air. Acid solutions are ideal because they have a high stability. For the best result it is recommended to calibrate with buffer-solution pH4.00 and pH7.00. The test-solutions should be used only once. Before dipping the electrode into the buffer solution, it must be rinsed with water and dabbed with clean fleece cloth. Each pollution of the buffer solution can change their value, and worsen the accuracy of the calibration.

Continue
page 15

Operating Instruction for pH/ORP- electrodes

Mounting

It is very important to mount the electrode immediately before starting up the system, to protect the electrode against drainage. For the mounting it necessary to use a 17 mm ring- or mouth spanner. Other tools will damage the glass protection sheath.

Mounting position

The mounting direction should be in range 10° and 170° from the vertical position

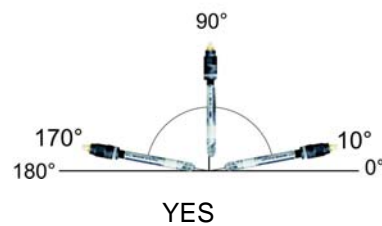

Cleaning and maintenance

Dirty electrodes supply incorrect results of measurement. Therefore they should be cleaned in regular intervals. In order not to damage the electrodes, the glass diaphragm should not be scratched or scouring agents treated.

- are dabbed rough contamination with a fleece cloth.
- oily and greasy contamination are eliminated with household cleaner (no scrubbing means).
- calcifying are solved by diluted hydrochloric acid.
- Protein contamination are solved with hydrochloric acid and pepsin mixture.
- contamination of sulfide can be separated in a mixture from hydrochloric acid and thiourea.

Ordering code

pH9648 - 1. - 2. - 3. - 4. - 5. - 6. - 7.

1. Terminal strip A

13 Input pH/ORP electrode
Temperature compensation with Pt100 or Pt1000 sensor

2. Terminal strip B

00 not installed
2R 2 alarm outputs relay
2T 2 alarm outputs transistor

3. Terminal strip C

00 not installed
2R 2 alarm outputs relay
2T 2 alarm outputs transistor
AO Analog output active pH/ORP
0/4 ... 20 mA and 0/2 ... 10 V DC, isolated
2A 2 analog outputs passive, isolated
4 ... 20 mA for pH/ORP (2A1) and temperature (2A2)

4. Terminal strip D supply voltage

0 230 V AC ± 10 % 50-60 Hz
1 115 V AC ± 10 % 50-60 Hz
4 24 V AC ± 10 % 50-60 Hz
5 24 V DC ± 15 %

5. Option

00 without option

6. Unit (appears in the unit field)

7. Additional text (will be placed in the field for additional text max. 3 x 90 mm, WxH)

Custom configuration on request!