

# Standard Signal Meter S 1010

Industry standard signals - integrated transmitter-supply

## Features

- LED-Display 14.2 mm red
- Indicating range  $\pm 9999(0)$  Digit
- Indicating range and decimal point free programmable
- Max. 2 alarm outputs, relay SPDT
- Analog output 0/4 ... 20 mA, 0/2 ... 10 V DC
- Field case with snap lid, 2 x M16x1.5 other cable glands see option 09 or on request
- Protection IP65



## General

The Standard-Signal-Meter S1010 has been designed for measuring industry standard signals 0/4 ... 20 mA or 0 ... 10 V DC. The device offers an integrated transmitter supply for direct connection of 2- and 3-wire transmitters for e.g. pressure or temperature. Indicating range and decimal point are free programmable in the range  $\pm 9999(0)$ git.

## Short information

Programming	Parameters are programmed via front-side membrane keypad.
Alarm outputs	Switching performance min. or max., hysteresis, on-delay time and off-delay time are programmable in range from 1 s up to 9 h.
Digital filter	With activated digital filter last 16 measured values will be averaged continuously and the result shown in the display.
Analog output	Proportional to the input signal an analog output signal 0 ... 20 mA/0 ... 10 V DC or 4 ... 20 mA/2 ... 10 V DC can be generated. Output changed automatically from current signal to voltage signal depending on burden.

## Technical data

### Power supply

Supply voltage	: 230V AC ±10%; 115V AC ±10%, 24V AC ±10% or 24 V DC ±15%	
Power consumption	: max. 3.5 VA	
Operating temperature	: -20 ... +55 °C Standard (extended temperature range on request)	
Rated voltage	: 250 V~ acc. VDE 0110 between input/output/supply voltage over-voltage categoric III	
Test voltage	: 4 kV~, between input/output/supply voltage	
☐ - conformity	: EN55022, EN60555, IEC61000-3/4/5/11/13	

### Input

Current input	: 0/4 ... 20 mA	Ri = 10 Ω
Voltage input	: 0 ... 10V	Ri = >100 kΩ
Accuracy	: < 0.1 % ±2 Digit	
Temperature coefficient	: 0.004 %/K	
Transmitter-supply	: U <sub>0</sub> appr. 24 V, Ri appr. 150 Ω, max. 50 mA (25 mA with relay and analog output)	

### Display

Display range	: LED red, 14.2 mm
Display range	: ±9999(0) with leading zero suppression
Parameter display	: LED 2-digit red, 7 mm (parameter - and output indicator)

### Output

Relay	: SPDT, < 250 V AC < 250 VA < 2 A, < 300 V DC < 50 W < 2 A
Analog output	: 0/4 ... 20 mA burden ≤500 Ω; 0/2 ... 10 V burden >500 Ω, not isolated to the input; automatic output changing (burden dependent)
Accuracy	: 0.1 %; TK 0.01 %/K

### Field case

Weight	: Case polyamide, with fibre-glass PA6-GF 15/15, Keypad polyester
Weight	: max. 450 g
Electrical connection	: Clamp terminals, 2 mm <sup>2</sup> single wire, 1.5 mm <sup>2</sup> flexible wire, AWG14
Protection	: IP65, terminals IP20, fingersafe acc. German BGV A3

## Dimensions

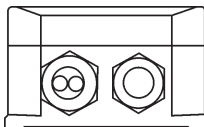
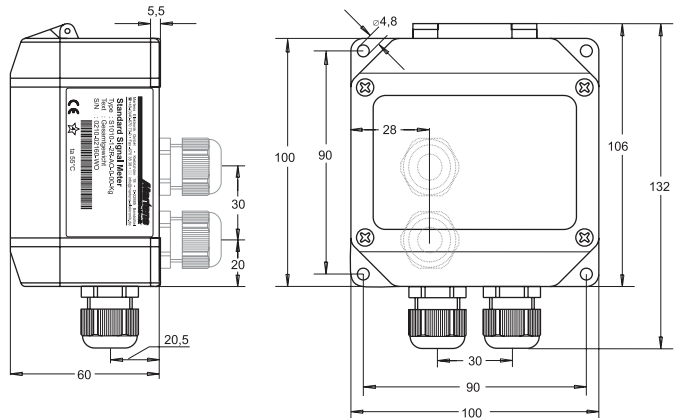

### Option 09

1 x M20x1.5 Multi (2 x d = 6 mm)  
 1 x M20x1.5

2 x M16x1.5  
 (in the base on request)

## Legend (open lid)

Terminal strip  
Terminal 1 and 13 not marked

## Connection diagram

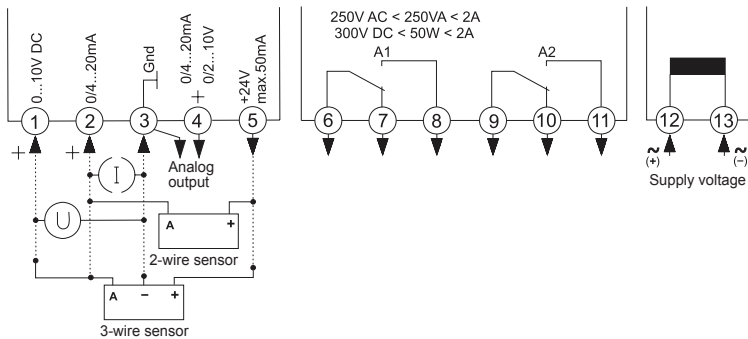

## Controls and indicators

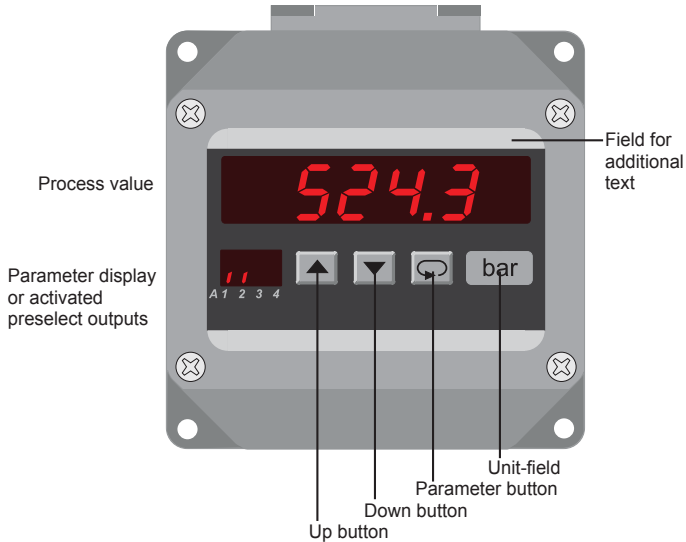

## Description

Operating of the device is arranged in 2 levels. The requested parameter can be called by button . For selections within a parameter or for entering data, use buttons and .

After power-on the device is located in the **Working level**. Set points of the alarm outputs can be programmed if they are available.

Pressing the button for more than 2 seconds, activates the **Configuration level**. Now all the parameters which defines the function of the device can be programmed. E.g. the switching performance of the alarm outputs, measuring input and the analog output.

After finishing the configuration or when no button was pushed for more than 2 minutes, the program returns to the Working level. Leaving the Configuration level is possible at any time by pressing the button for more than 2 seconds.

Parameter display as status indicator for the alarm outputs A1-A2.

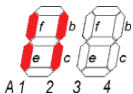

Segments f (A1) and/or b (A2) are flashing with 2 Hz, when delay time is active.

Segments e (A1) or c (A2) are output indicators.

## Error codes:

**Display flashes** If the input signal is more than 3 % outside of the programmed measurement range the A/D- converter is over driven and the display flashes with appr. 1 Hz.

**Error!** EEPROM test. Reading this message, a program error has been occurred. When pushing the button a copy of the EEPROM will be reloaded and the device will work with the factory settings. If this copy does not work, please ship the device to factory for repair service.

**L o c** Program lockout. See configuration page 7.

**Start-up note:** The device has to be configured, before it can be used

⇒ see page 6

### Notes to representation



Parameter is only displayed when configured



Parameter is only displayed when feature is included (see order code)

**Please Note:** All parameters can be called if they are not blocked by other programmed parameters and if they are available. **Factory settings** are shown in the display.

### Working level

Button

Display

Description

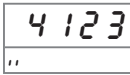

Actual value.

Alarm output indication  
(only if installed and activated).

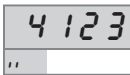

Display brightness (permanent changing possible)  
Setting possible in 9 steps with buttons ▲ and ▼.



Display maximum reading.  
Reset with buttons ▲ or ▼, or at every power off.



Display minimum reading.  
Reset with buttons ▲ or ▼, or at every power off.

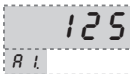



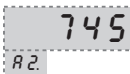













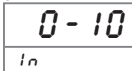

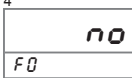





Setpoint output A1.  
Setting possible from  $S_t$  ...  $E_n$  with buttons ▲ and ▼.  
 $S_t$  (start value) ...  $E_n$  (end value)





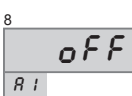

















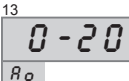

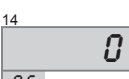
Setpoint output A2.  
Setting possible from  $S_t$  ...  $E_n$  with buttons ▲ and ▼.  
 $S_t$  (start value) ...  $E_n$  (end value)



## Configuration

Button	Display	Description (Display graphic shows factory settings)
 Press 2 s	1  F <sub>1</sub>	Digitalfilter oFFf, on Averaging of the last 16 measured values continuously. Selection with buttons ▲ and ▼ .
	2  S <sub>c</sub>	Indicating correction. Setting possible from - 99 ... 99 digit with buttons ▲ and ▼ .
 	3  I <sub>n</sub>	Selection of the input signal. 0 - 10 ; 0 - 20 ; 4 - 20 Selection with buttons ▲ and ▼ .
 	4  F <sub>0</sub>	Fixed Zero 0, z.B 3690 + 0 no ; y E 5 Selection with buttons ▲ and ▼ .
 	5  dP	Decimal point position F <sub>0</sub> = no 0 .0 .00 .000 F <sub>0</sub> = y E 5 0 .00 .000 .0000 Selection with buttons ▲ and ▼ .
 	6  S <sub>t</sub>	Start value for indicating range and analog output. Setting possible from - 9999 ... 9999 digit with buttons ▲ and ▼ . In case of modification new configuration of the alarm outputs is necessary.
 	7  E <sub>n</sub>	End value for indicating range and analog output. Setting possible from - 9999 ... 9999 digit with buttons ▲ and ▼ . In case of modification new configuration of the alarm outputs is necessary. If S <sub>t</sub> > E <sub>n</sub> , output works with a decreasing characteristic.
 	8  R <sub>1</sub>	Switching performance output A1. Function oFFf ; onL (min) ; onH (max). If activated the start value will be loaded for set point Selection with buttons ▲ and ▼ .
 	9  R <sub>1</sub>	Set point output A1. Setting possible from S <sub>t</sub> (start value) ... E <sub>n</sub> (end value) with buttons ▲ and ▼ .

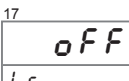
continue  
 page 7

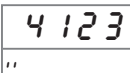
Button	Display	Description (Display graphic shows factory settings)
↓ 	10 	Hysteresis A1 Setting possible from 1 ... 9999 digit with buttons ▲ and ▼ .
		
↓ 	11 	Switch-on delay time output A1. Setting possible from 0.00.00 ... 9.00.00 (h.mm.ss) with buttons ▲ and ▼ .
		
↓ 	12 	Switch-off delay time output A1. Setting possible from 0.00.00 ... 9.00.00 (h.mm.ss) with buttons ▲ and ▼ .
		Note: Switching performance and set points for alarm output A2 has to be configured in the same way.
↓ 	13 	Analog output. 0 - 20 mA (0 - 10 V DC) or 4 - 20 mA (2 - 10 V DC). Changing from current to voltage output is load-dependent (≤ 500 Ω = current output, > 500 Ω = voltage output). Selection with buttons ▲ and ▼ .
		
↓ 	14 	Analog output start value (Option 08) Setting possible from 5 t ... E n of the display range with buttons ▲ and ▼ .
		
↓ 	15 	Analog output end value (Option 08) Setting possible from 5 t ... E n of the display range with buttons ▲ and ▼ .
		Note: If the display range would be changed afterwards, the range of the analog output get the same values. Start- and end value of the analog output can be set anywhere in the display range. If RE < R5 the output works with a decreasing characteristic.
↓ 	16 	Code for factory settings.
		
↓ 	17 	Programming lock. oFF = no lock Lo n F. = configuration level locked R L L = all parameters locked Selection with buttons ▲ and ▼ .
		
		Return to the working level

## Ordering code

S1010 -  1. -  2. -  3. -  4. -  5. -  6. -  7.

### 1. Input

1 Input standard signals  
0/4 ... 20 mA, 0 ... 10 V DC,  
integrated transmitter-supply 24 V DC max. 50 mA

### 2. Alarm output

00 not installed  
2R 2 alarm outputs relay SPDT

### 3. Analog output

00 not installed  
AO Analog output 0/4 ... 20 mA or 0/2 ... 10 V DC  
not isolated

### 4. Supply voltage

0 230 V AC ± 10 % 50-60 Hz  
1 115 V AC ± 10 % 50-60 Hz  
4 24 V AC ± 10 % 50-60 Hz  
5 24 V DC ± 15 %

### 5. Option

00 without option  
01 min- and max- peak hold  
07 display brightness programmable  
08 analog output free programmable  
09 1 x M20x1.5 Multi (2 x Ø6 mm), 1 x M20x1.5

### 6. Unit (appears in the unit field)

### 7. Additional text (will be placed in the field for additional text, max. 3 x 70 mm, HxW)

Custom configuration on request